



1250-1280 P/D Guida rapida all'utilizzo



La seguente documentazione non vuole sostituire il manuale uso e manutenzione, ma vuole essere un documento per la consultazione rapida. Prima di utilizzare la macchina leggere attentamente il manuale uso e manutenzione, contenuto nell'imballo della macchina e rispettare rigorosamente tutte le prescrizioni contenute in esso.

PREPARAZIONE E FUNZIONAMENTO

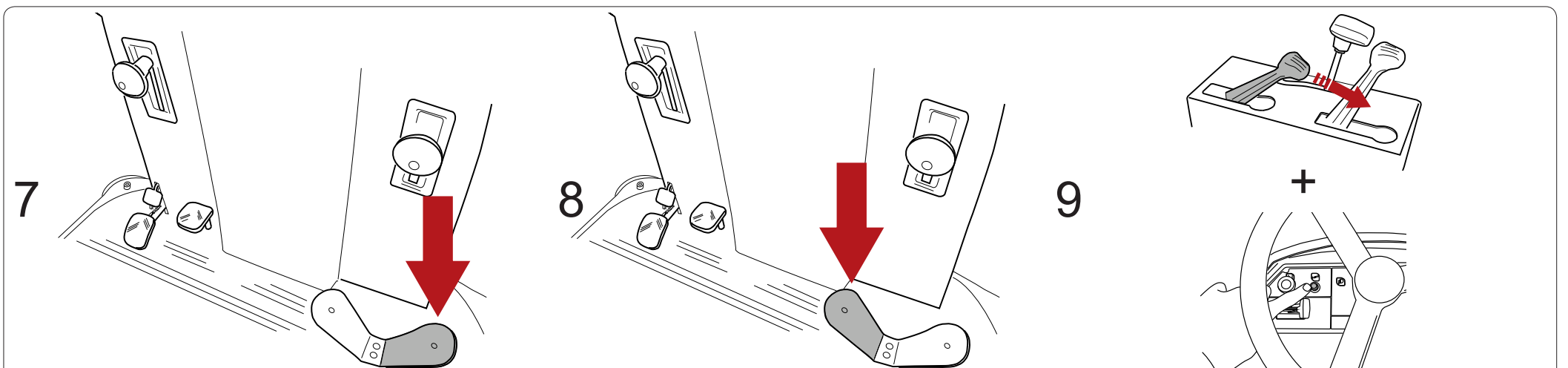
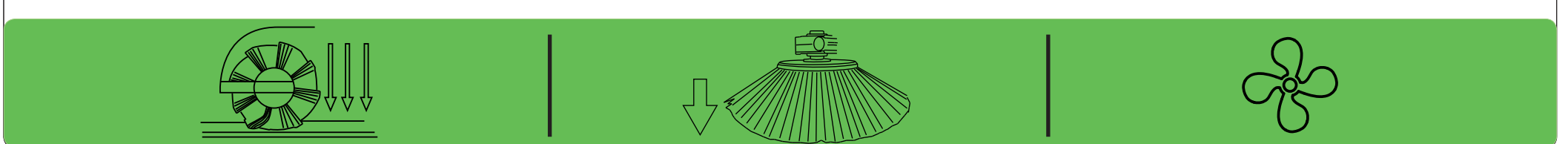
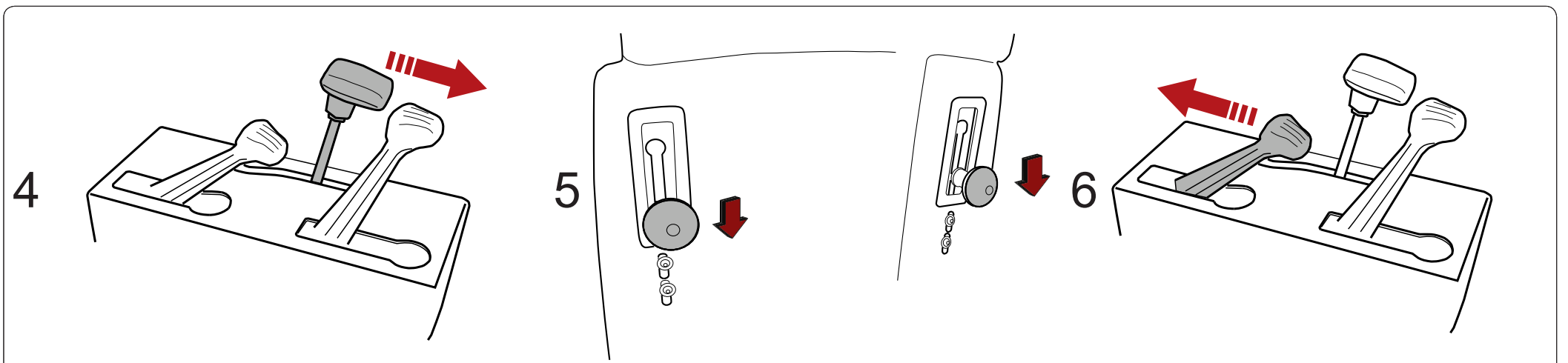
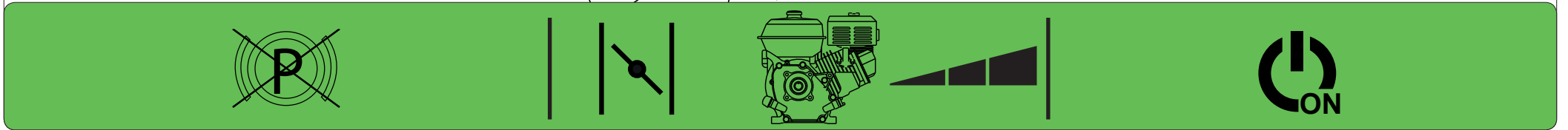
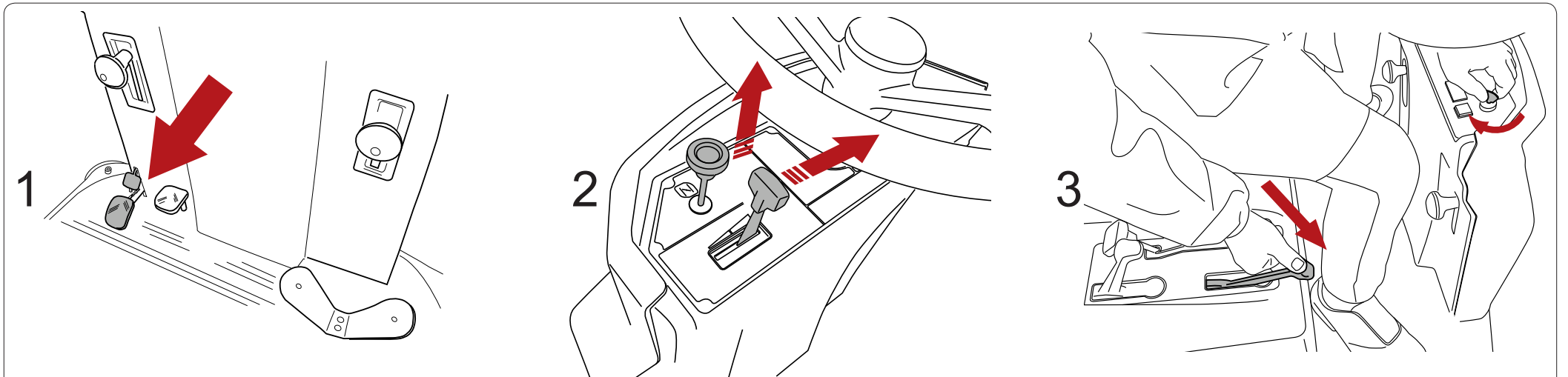

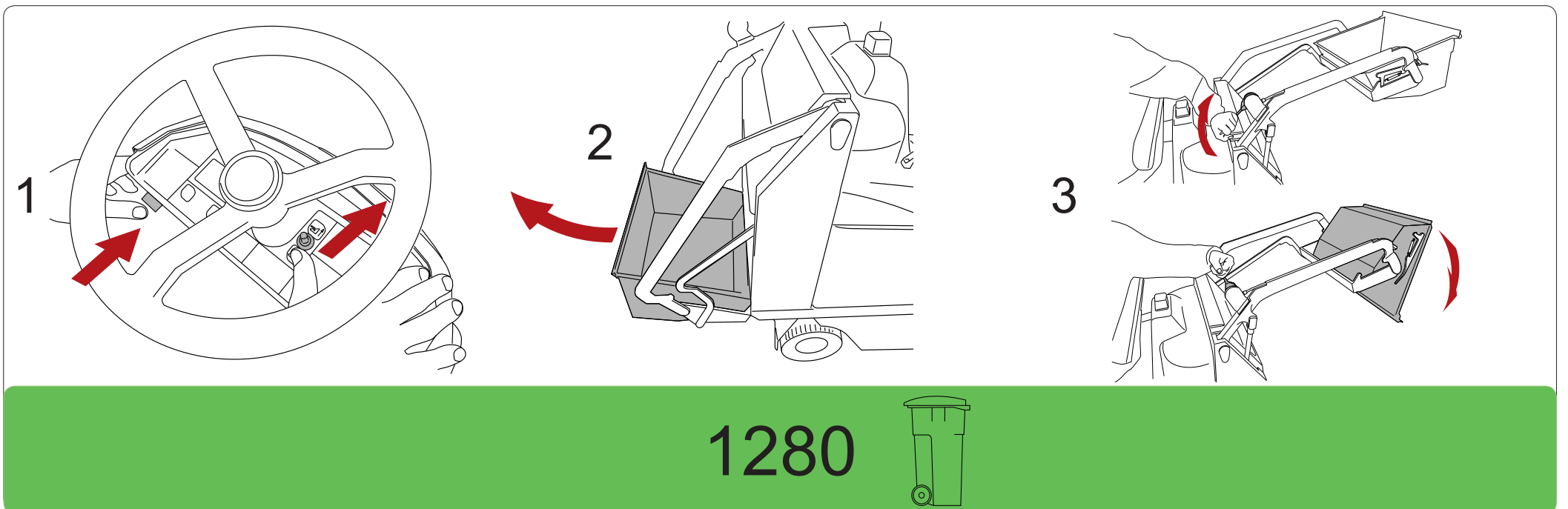
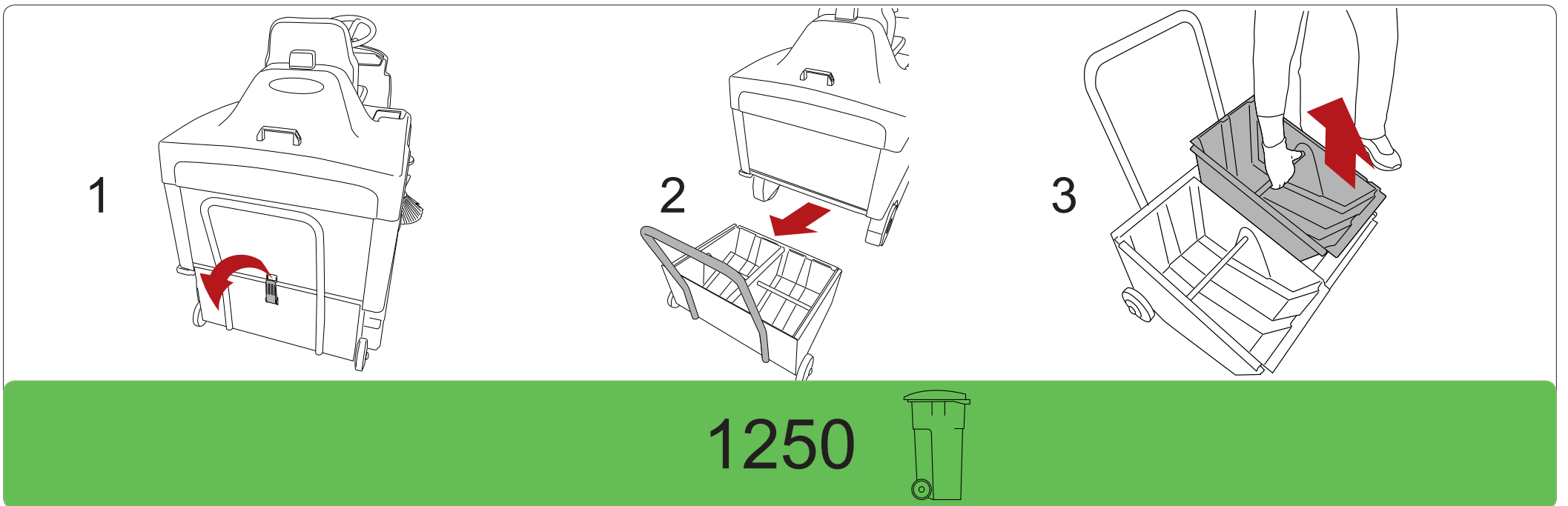

MANUTENZIONE GIORNALIERA

