

OWNER'S MANUAL

***21" & 27"
BUFFER
THE ANSWER***



*Powered by the
EPA/Carb certified
Kawasaki
603cc Engine*



201 COMMERCE DRIVE • MONTGOMERYVILLE, PA 18936

215-393-4700 • 800-331-1423 • FAX 215-393-4800

IMPORTANT SAFETY INSTRUCTIONS

READ and UNDERSTAND all instructions and warnings before operating this machine!



WARNING

Do not store or use gasoline or other flammable vapors and liquids in the vicinity of this machine. Always store equipment away from heater rooms, boilers, gas-fired water heaters or any other source of open flame. Propane is highly flammable. Always store LPG tanks (full or empty) outside in a secure, well ventilated area.

NO SMOKING, NO SPARKS, NO FLAMES NEAR UNIT OR LPG TANK.

Operate only in well ventilated areas. Buildings must be provided with:

- A. *A continuous mechanical ventilation that removes the products of combustion to the outdoors of not less than 300 CFM for each 10,000 BTUH or fraction thereof; or*
- B. *Natural ventilation of not less than 300 CFM for each 10,000 BTUH input or fraction thereof, based on a maximum of one-quarter air exchange per hour for the net building volume.*

If you smell LPG gas, stop the unit and check for leaks. Also open windows, don't touch electrical switches, extinguish any open flames. Call your gas supplier if no leaks are found.

Do not adjust the fuel system without the proper analysis equipment.



WARNING

Never tilt the equipment on its side for pad, belt or brush replacement. It is designed to tilt back on its rear wheel and handle for maintenance and repair. A second person should aid in lifting and securing equipment for repair.

Never tilt & transport while engine is running.

Keep hands and feet clear of all moving parts.

Never try to replace parts or repair equipment with machine running.

Turn the gas off at the tank to kill the engine.

Remove the LPG tank and store it in an approved area when not in use. A "NO SMOKING" sign should be permanently displayed at the storage area.

Always vent an over-full bottle using the tank's bleed valve, out of doors away from all closed places and away from any fire or flame producing device. Vent until the white vapor turns clear.

Keep all objects clear of the exhaust system during and after operation.

Do not leave this machine unattended while the engine is running.

Do not operate equipment in one location for more than a few seconds. Damage to floor surface can occur.

Always store equipment away from possible damage by falling objects in warehouse-type areas. Always store LPG tanks outside in a secure, well-ventilated area.

When the LPG tank is attached to the machine and not running, the operator should not leave the machine unattended except for short periods of time such as rest stops, washroom or meal stops.

The operator must completely understand all instructions, warnings and operating procedures before using this machine.

The manufacturer's warranty will be voided if the machine is not maintained in accordance with this manual's recommended maintenance instructions and the engine manufacturer's recommended maintenance procedures. Failure to do so may cause damage to the machine, equipment, furniture, buildings or personal injury!

A maintenance record should be kept indicating date of service, hours on engine, and work done.

TRANSPORT & PREPARATION



WARNING

Follow the instructions given in this booklet, the Engine's Owners Manual and the training given by your supervisor for the safe operation of this machine. Failure to do so can result in personal injury and/or damage to the machine or property.

DO NOT OPERATE THIS MACHINE IN AN EXPLOSIVE ENVIRONMENT!

THIS PROPANE MACHINE IS INTENDED FOR COMMERCIAL USE.

**WARNING**

Do not use "T" handle when attempting to tilt back machine for service or cleaning. The "T" handle is designed for control during operation only.

Do not use excessive vertical pressure.

I. PREPARATION**A. Check that the suggested maintenance schedule has been observed:**

All machines are equipped with a multi-function maintenance meter. The functions include the following: hour meter, service alert and tachometer. (See Engine Maintenance Meter Instructions on p4).

B. Check the engine oil before every operation:

Make sure the machine is level when checking the oil. Always take 2 readings of the dipstick before adding oil. If the oil level is below the full mark, add just enough oil to the engine to bring the oil level up to the full mark. **Never over fill.** Follow the guidelines in your Engine Owners Manual. Check for foreign material on the dipstick.

C. Properly fill and check your LPG tank and all LPG fuel lines for leaks:

1. Every tank has been pressure and leak tested. However, every time a tank is filled and/or connected to the machine it should be soap tested. All LPG lines must be pressurized and every inch of line and connections must be sprayed. If you find a leak, make the proper repairs before operating the machine.

NOTE: The connection and disconnection of the LPG tank must be done in a well ventilated area with NO source of ignition within 10 feet (3 meters) from the point of connection.

2. **Never over fill the LPG tank!** The LPG tank is designed to hold just 20 pounds of propane. Make sure to weigh the tank as it is being filled. The gross weight of a full tank should not exceed 48 pounds. If while operating the machine, you notice frost forming on the LPG lines or the regulator, your tank has been over filled. If you continue to operate the machine in this condition, damage will occur. The excess propane in the tank must be removed before normal operations resume. The bleeding of a propane tank should be done in a safe location outside the building. In some cases the regulator must defrost before restarting the engine.

D. Connecting the high pressure hose to the LPG Tank:

Make sure the couplers are in line and screwed together hand tight. If this is not done properly, fuel will not pass through to the regulator. Never complete the connection of the tanks to the machine by using a wrench. Always do it by hand. Listen for the rush of fuel to the lock-out device when you open the tank valve. If you hear this, it indicates a good connection has been made at the tank.

**WARNING**

NEVER CHANGE OR ALTER THE PROPANE CONTROL EQUIPMENT!

E. Install fresh pads or brushes before every job:

To install a fresh pad, set the machine down in the rear. Unscrew and remove the pad-centering ring. Remove the old pad and center the new pad onto the pad driver. Reinstall the pad-centering ring. Never "flip" a pad. Keep the same side down throughout the life of the pad. Even after a pad is cleaned, you can tell the down side by the centering ring indentation. This practice will increase the pad life and help maintain a properly functioning pad driver. **NEVER TILT A MACHINE ON ITS SIDE!**

II. STARTING THE ENGINE

A. Open propane (LPG) tank valve (counter clockwise).

B. Set throttle control at idle.

C. Battery start – turn key to the start position & move throttle toward fast position. If engine does not start, release key and return to step "B".

D. Electric start – push "Start" button and move throttle toward fast position until engine starts. Starter should not be engaged for more than 10 seconds at a time.

- **When a propane tank is overfilled it may temporarily cause the fuel regulator to malfunction. Remove the tank to a well ventilated location. Release some gas until the cloud disappears and escaping gas is "clear." Reinstall tank.**
- **All machines are equipped with tamper proof fuel systems. If a fuel problem exists, contact an authorized service center.**

- **Propane tanks should be removed & stored in a protected off site area.**

III. OPERATION

Provide and use ear protection during operation.

Never let an untrained person operate or perform repairs on the machine. They may hurt themselves, damage the floor or the equipment.

Engine speed not to exceed 3400 RPM.

This machine is not suitable for picking up hazardous dust.

Do not use on surfaces with a gradient exceeding 2%.

IV. STOPPING THE ENGINE

Turn the propane tank valve clockwise to a closed position and turn the key OFF.

NOTE: The exhaust system will be very hot and takes several minutes to cool, so keep yourself and all materials clear.

V. PROCEDURES

Follow machine (straight ahead) at moderate walking speed. Keep moving.

- **Do not operate the machine in one location for more than a few seconds — it will damage — “burn” the finish.**
- **When operation is completed remove tank and store in a secure, protected off site (preferably outdoor) location.**
- **Do not use for scrubbing operations.**
- **Never tilt back machine to maintenance position while engine is running.**
- **Never reach under protective shroud when engine is running.**

VI. MAINTENANCE

A. Machine & engine maintenance

1. Refer to engine manufacturer's owners manual and comply completely with the instructions. Change the oil and filter according to the Engine Owners Manual.
2. Keep a good service log on each machine with the date, hour meter reading, type(s) of service performed and the name of the person who performed them.
3. Clean the entire unit after each use. When

cleaning the unit, check for possible loose nuts and bolts.

B. Engine maintenance meter

This multi-function meter acts as a preventive maintenance tool, which benefits you with increased fuel economy, less down-time and longer engine life.

The meter's displays are:

Hour Meter: Displays total run hours when machine is off.

Tachometer: Indicates engine RPM during operation.

Service Alert: The display flashes to alert you to lube and change the oil at 25 hour intervals. The service alert only flashes during operation and it warns you to change the oil for only two hours. After the two hours is reached, the alert will automatically reset to the next 25 hour interval. Therefore, it is recommended that a separate maintenance log be kept to track oil changes.

Remember that being safe is a full-time, every day job. Follow all information posted on the machine and the LPG tank.

Never allow anyone to operate this machine who has not read or cannot understand the given instructions.

C. Troubleshooting the electrical system

1. Check all wire connections for obvious problems. Remove LPG tank, then remove battery box cover. Check all connections visibly and physically. If any “loose”, damaged or unconnected wires are noticed, replace or repair as needed.

2. Check the battery posts and wires. **Always wear a face shield, safety glasses and protective clothing when working around a battery!** The gases can be explosive and the acid is highly corrosive to metals, cloth and ALL HUMAN TISSUE (skin, eyes, etc.) If the battery post(s) are corroded, remove the wires and clean posts and wires. Applying some axle grease on the posts of the battery after they are cleaned will slow down the battery corrosion process.

If nothing obvious is noted, a more detailed investigation is warranted. Before any such troubleshooting begins, the following things should be done:

- a. Replace propane LPG tank with one from a machine that runs.

b. Charge the battery or provide an absolute source of 12 volt DC power capable of 50 amperes total output. (A pair of good jumper cables from your car or truck battery will suffice.) Equip yourself with an inexpensive 12 volt test light.

c. If the trouble seems to be in the electrical control equipment, you may wish to disconnect the starter from the system so as to check the system without spinning the engine.

d. Battery rundown. A common problem is letting the battery run down. What usually happens is that it takes the crew a few jobs to get used to the whole system, so the machine is stopped and started quite often. Key left in on position, when engine is turned off, will result in battery running down – dying.

D. Belt Inspection & Replacement

Inspection

- Fold T-Handle to forward position
- Tilt machine back on rear of body & handle
- If belt is worn, cracked or shredding, belt needs to be replaced.

Replacement

- Place 3/4" wrench on end of the shaft on the top of the buffer body.
- Turn pad driver counter-clockwise to remove.
- Take belt off by turning 3/4" wrench on shaft and removing belt from pad driver pulley and engine crank pulley.
- Check pad driver pulley & engine crank pulley for correct alignment.
- Install new belt on engine crank pulley & pad driver pulley, using 3/4" wrench.
- Install belt on tension pulley
- Install pad drive onto shaft, and return buffer to operating position.

E. Adjusting Pad Pressure

The pad pressure may be adjusted by moving the wheels:

- Forward to reduce weight on the buffer pad or
- Backward to increase the weight

This adjustment may be required to adjust to different floor finishes or to the weight variance of aluminum or steel propane tanks.

KAWASAKI ENGINES

Tune-up Specifications

ITEM	SPECIFICATIONS
Ignition Timing	Unadjustable
Spark Plugs: Gap	Champion – RCJ8Y 0.75 mm (0.30 in)
Low Idle Speed	1500 RPM
High Idle Speed	3400 RPM
Valve Clearance	IN: 0.10-0.15 mm (0.004-0.006 in) EX: 0.10-0.15 mm (0.004-0.006 in)
Other Specifications	No other adjustment needed

NOTE: High and low idle speeds may vary depending on the equipment on which the engine is used. Refer to the equipment specifications.

Engine Oil

Check the engine oil daily before starting the engine otherwise shortage of the engine oil may cause serious damage to the engine such as seizure.

- Place the engine on a level surface. Clean the area around the oil gauge before removing it.
- Remove the oil gauge and wipe it with a clean cloth.
- Pour the oil slowly to “FULL” mark on the oil gauge.
- Insert the oil gauge into the tube WITHOUT SCREWING IT IN.
- Remove the oil gauge to check the oil level. The oil level should be between “ADD” and “FULL” marks. Do not overfill.
- Install and tighten the oil gauge.

The following engine oils are recommended:

API Service Classification: SF, SG, SH, or SJ.

Oil Viscosity

Choose the viscosity according to the temperature as follows:

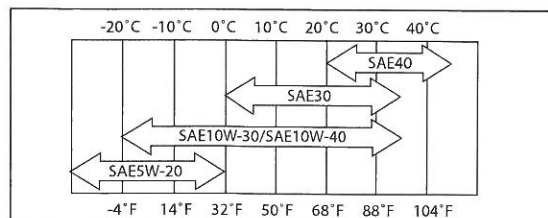

NOTE: Using multi grade oils (5W-20, 10W-30, and 10W-40) will increase oil consumption. Check oil level more frequently.

Engine Oil Capacity

FH381V	1.5 L (1.6 US qt.) when oil filter is not removed
FH500V	1.7 L (1.8 US qt.) when oil filter is removed
FH541V	1.7 L (1.8 US qt.) when oil filter is removed

Oil Change

Change oil after **first 8 hours of operation**. Thereafter change oil **every 50 hours**.

- Run the engine to warm oil.
- Be sure the engine (equipment) is level.
- Stop the engine.
- Open the oil drain valve and drain the oil into suitable container while engine is warm.

! WARNING!

Hot engine oil can cause severe burns. Allow engine temperature to drop from hot to warm level before draining and handling oil.

Oil Drain Plug

- Close the oil drain valve.
- Remove oil gauge and refill with fresh oil (See "Recommended Oils" on p5).
- Check the oil level (see "Preparation" on p3 for oil level check).

Oil Filter Change

- Change the oil filter **every 100 hours of operation**.

! WARNING!

Hot engine oil can cause severe burns. Allow engine temperature to drop from hot to warm level before attempting to remove oil filter.

! CAUTION!

Before removing the oil filter, place a suitable pan under filter connection.

- Drain engine oil into a suitable container.
- Rotate the oil filter (A) counterclockwise to remove it.
- Coat a film of clean engine oil on seal of new filter.
- Install new filter rotating it clockwise until seal contacts mounting surface (B). Then rotate filter 3/4 turn more by hand.
- Supply engine oil as specified.
- Run the engine for about 3 minutes, stop engine, and check oil leakage around the filter.
- Add oil to compensate for oil level drop due to oil filter capacity (See "Oil Level Check" on p3).

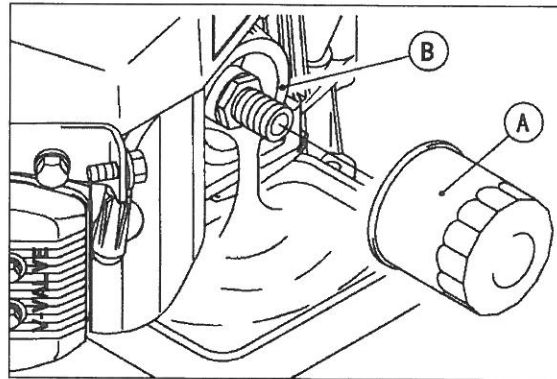

! WARNING!

Engine oil is a toxic substance. Dispose of used oil properly. Contact your local authorities for approved disposal methods or possible recycling.

KAWASAKI ENGINE BATTERY START WIRING DIAGRAM

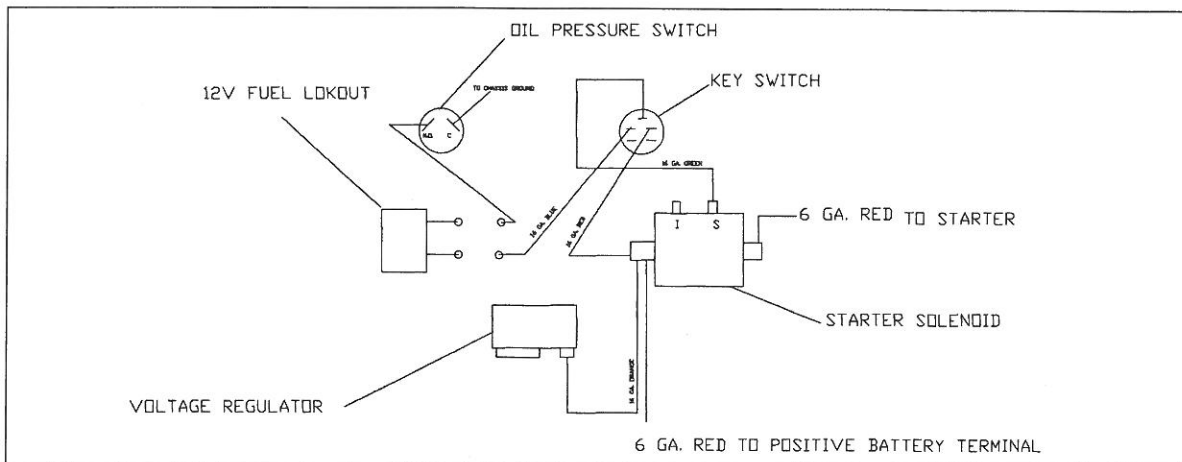

KAWASAKI ENGINE MAINTENANCE SCHEDULE

MAINTENANCE	INTERVAL						
	Daily	First 8 hr.	Every 25 Hr.	Every 50 hr.	Every 100 hr.	Every 200 hr.	Every 300 hr.
Check and add engine oil	•						
Check for loose or lost nuts and screws	•						
Check for fuel and oil leakage	•						
Check battery electrolyte level	•						
Check or clean air intake screen	•						
Clean air cleaner foam element			•				
Clean air cleaner paper element				•			
Clean dust and dirt from cylinder and cylinder head fins					•		
Tighten nuts and screws					•		
Change engine oil		•		•			
Clean and gap spark plugs					•		
Change oil filter					•		
Replace air cleaner paper element					•		
Clean combustion chambers							•
Clean and adjust valve clearance				•*			•
Clean and lap valve seating surface							•

*After the 1st 50 hours

ENGINE TROUBLESHOOTING

COMMON PROBLEMS & PROBABLE CAUSES

SOLUTIONS

Engine cranks but will not start

- Fuel cylinder is empty
- Shutoff valve is closed
- Clogged, obstructed, kinked or cut fuel or vacuum line
- Spark plug lead disconnected
- Faulty choke or throttle settings
- Faulty ignition coil
- Faulty kill switch
- Faulty regulator

- Refill cylinder
- Open valve
- Remove obstruction or replace line
- Connect lead to spark plug
- Set controls to correct positions
- Replace coil
- Replace switch
- Replace regulator

Engine starts hard

- Faulty choke or throttle settings
- Clogged, obstructed, kinked or cut fuel or vacuum line
- Faulty regulator
- Low compression

- Set controls to correct position
- Remove obstruction or replace line
- Replace regulator
- Valves need adjustment
- Have engine serviced by a trained technician

Engine will not crank

- Battery is discharged
- Loose or faulty connections or wires
- Faulty ignition key switch or starter control switch

- Charge or replace battery
- Tighten, repair or replace wires
- Repair or replace switch(es)

Engine overheats

- Incorrect fuel settings
- Air intake filter screen or cooling fins clogged
- Low oil level

- Have engine serviced
- Clean and clear debris or replace filter
- Check and add oil

Exhaust emissions or propane odor

- Carburetor or regulator setting incorrect
- Dirty or clogged air filter
- Choke engaged
- Loose fittings, clamps or hoses cracked, hoses cut or leaking

- Have engine serviced by a trained technician
- Replace air filter
- Adjust to correct settings
- Tighten or seal; check with soap and water solution, if bubbles appear, part is still leaking; replace

1
164-14FN

WIRE PARTS
1/4-20 FLANGE NUT

BODY ASSEMBLY

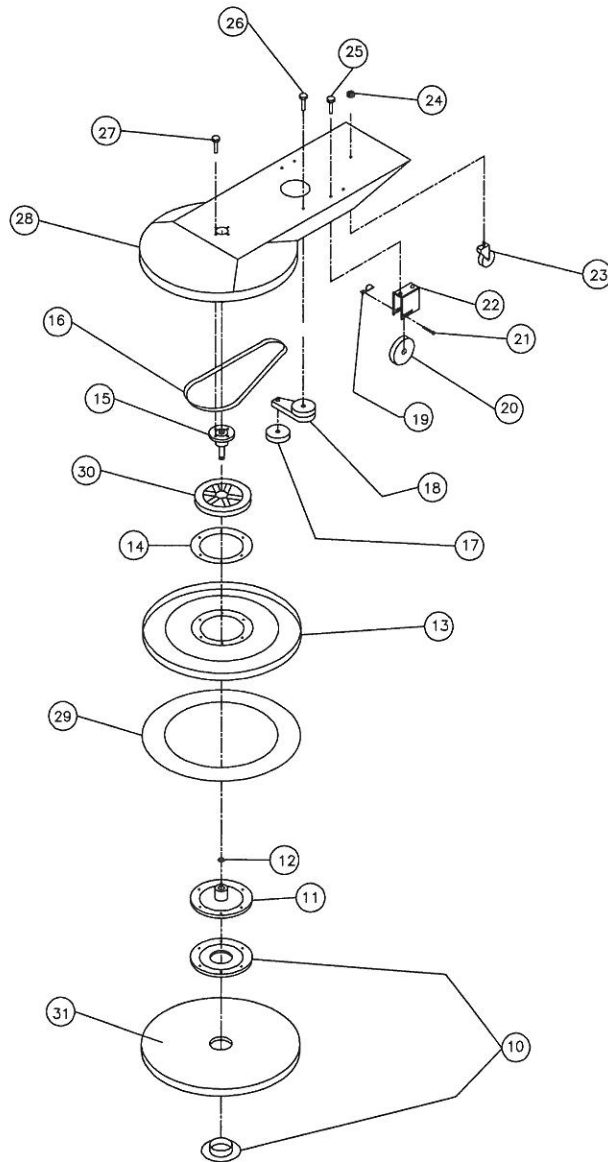

PARTS LIST FOR 21" BUFFER BODY ASSEMBLY

PART #	DESCRIPTION	PART #	QTY
10	PAD RETAINER (CENTER LOK II)	201-LOK	1
11	PAD DRIVE HUB	011-6-2740	1
12	WASHER	011-6-2770	1
13	PAD DRIVER	011-7-2175	1
14	PAD DRIVER SUPPORT RING	011-6-2750	1
15	SPINDLE ASSEMBLY (WITH HUB & BEARINGS)	011-6-2730	1
16	BELT	011-7-2190	1
17	TENSIONER PULLEY	011-6-2795A	1
18	BELT TENSIONER	011-6-2795	1
19	HITCH PIN CLIP	011-6-2762	2
20	5" WHEEL	156-ACPLY-5J3	2
21	CLEVIS PIN	011-6-2761	2
22	WHEEL BRACKET	011-6-2760	2
23	SWIVEL CASTOR	011-6-2755	1
24	NUT 1/2-13X1 1/2	164-22008	1
25	BOLT 5/16-18X1 1/4	164-10065	4
26	BOLT 3/8-16X2	164-10123	1
27	BOLT 1/2-13X1	164-10211	4
28	21" ALUMINUM BODY FRAME	011-7-2100	1
29	21" MIGHTY LOK	254-16*20.5	1
30	SPINDLE PULLEY (6 3/4")	011-7-2185	1
31	21" BEIGE PAD	250-PT21	1

BODY ASSEMBLY

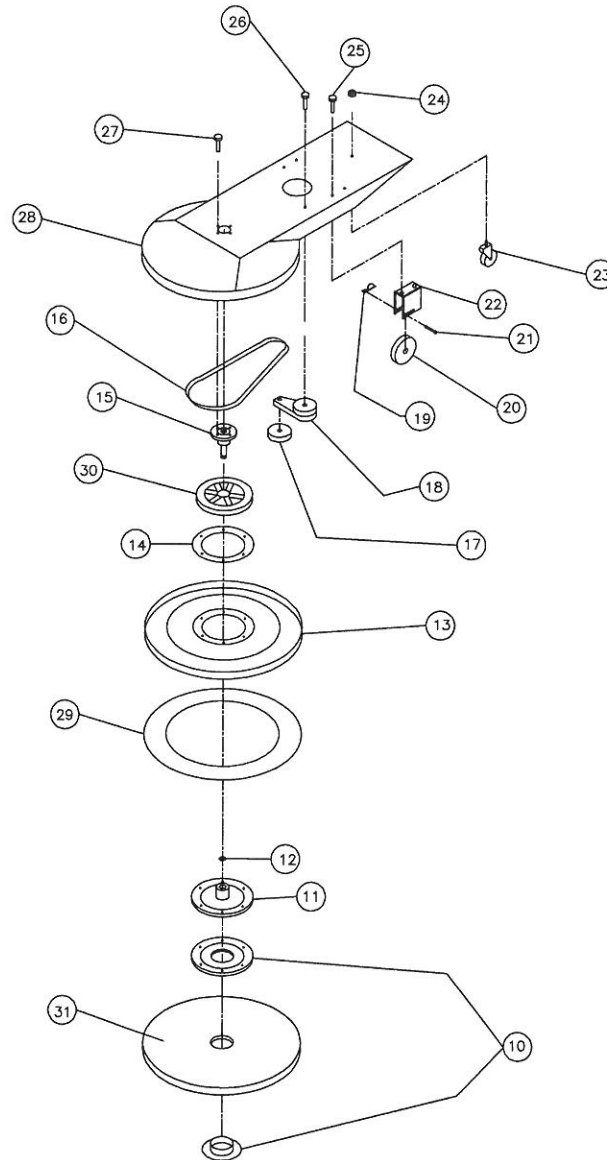

PARTS LIST FOR 27" BUFFER BODY ASSEMBLY

PART #	DESCRIPTION	PART #	QTY
10	PAD RETAINER (CENTER LOK II)	201-LOK	1
11	PAD DRIVE HUB	011-6-2740	1
12	WASHER	011-6-2770	1
13	PAD DRIVER WITH MIGHTY LOK	011-6-2765	1
14	PAD DRIVER SUPPORT RING	011-6-2750	1
15	SPINDLE ASSEMBLY (WITH HUB & BEARINGS)	011-6-2730	1
16	BELT	011-6-2790	1
17	TENSIONER PULLEY	011-6-2795A	1
18	BELT TENSIONER	011-6-2795	1
19	HITCH PIN CLIP	011-6-2762	2
20	5" WHEEL	156-ACPLY-5J3	2
21	CLEVIS PIN	011-6-2761	2
22	WHEEL BRACKET	011-6-2760	2
23	SWIVEL CASTOR	011-6-2755	1
24	NUT 1/2-13X1 1/2	164-22008	1
25	BOLT 5/16-18X1 1/4	164-10065	4
26	BOLT 3/8-16X2	164-10123	1
27	BOLT 1/2-13X1	164-10211	4
28	27" ALUMINUM BODY FRAME	011-6-2700	1
29	27" MIGHTY LOK	254-205*26.25	1
30	SPINDLE PULLEY (7 1/2")	011-6-2785	1
31	27" BEIGE PAD	250-PT27	1

FUEL SYSTEM

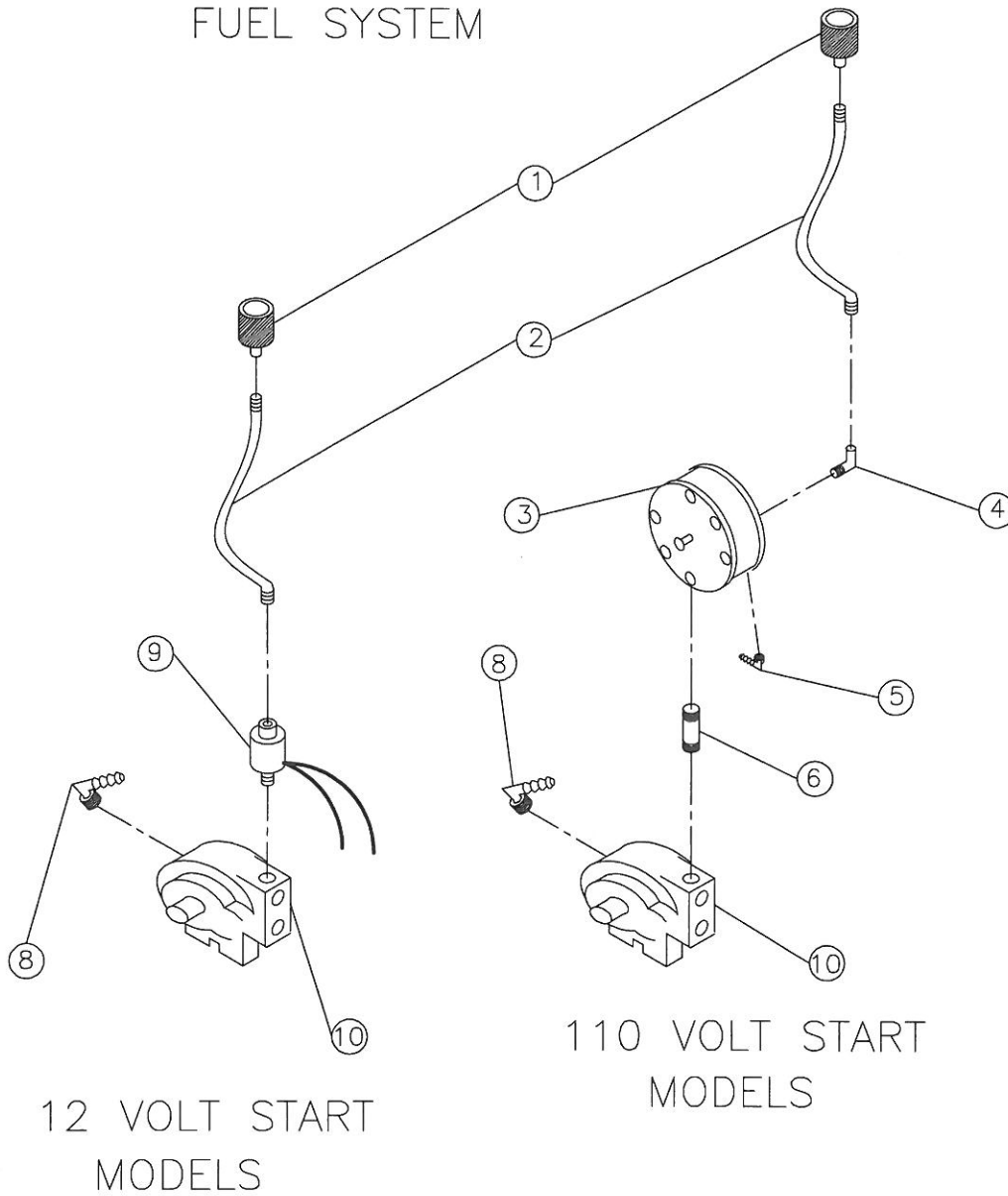

PARTS LIST FOR BUFFER FUEL SYSTEM

PART #	DESCRIPTION	PART #	QTY
1	QUICK COUPLER	152-700	1
2	LPG HOSE 14"	267-P5561-14	1
	LPG HOSE 20"	267-P5561-0410	1
3	FUEL LOK-OUT (VACUUM)	152-300	1
4	90° FITTING	177-116B04	1
5	VACUUM HOSE FITTING	166-62029	1
6	1 1/2" NIPPLE	177-56021	1
8	FUEL HOSE FITTING	166-62039	1
9	FUEL LOK-OUT (12 VOLT)	152-N3-0173-1	1
10	FUEL REGULATOR (T60-E)	152-500	1

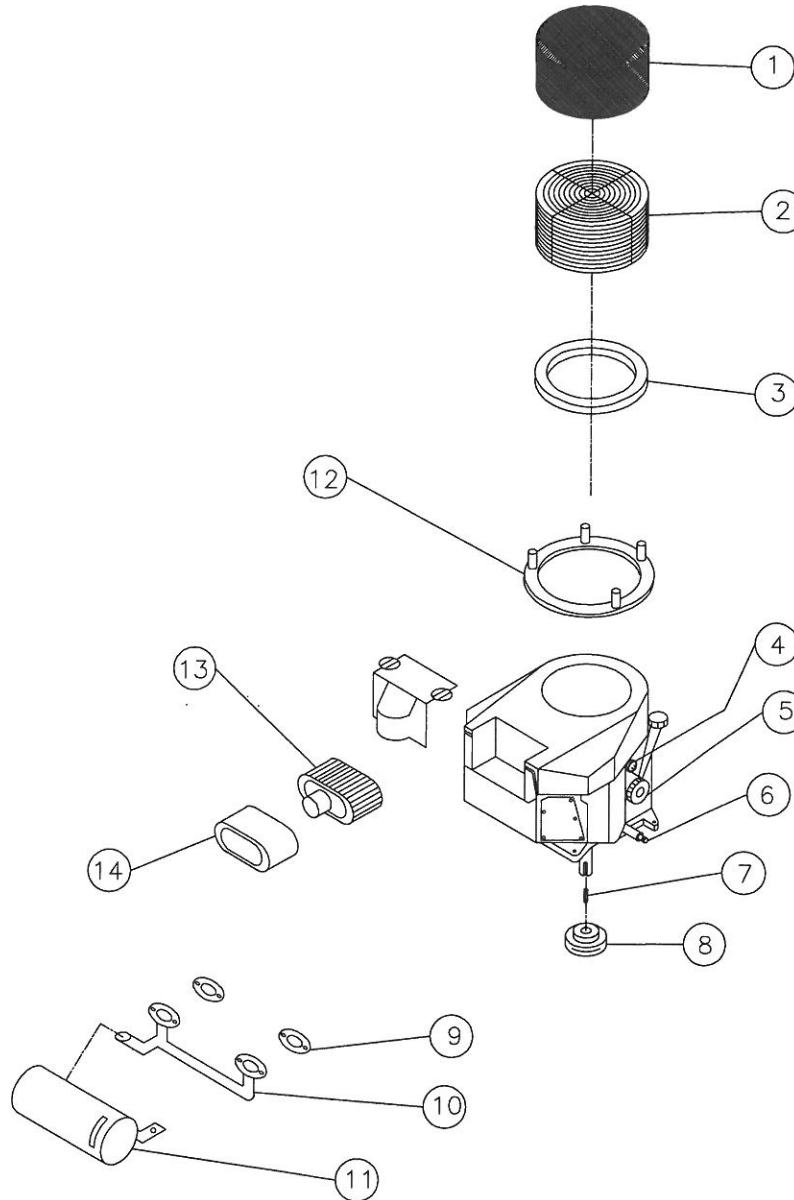

KAWASAKI 603cc ENGINE

PART #	DESCRIPTION	PART #	QTY
1.	Foam Hat Filter	186-271964	(1)
2.	Debris Screen	309-18540	(1)
3.	Foam Hat Seal	175-7.75*9.25*1	(1)
4.	Oil Pressure Switch	152-N3-0082	(1)
5.	Oil Filter	309-49065-7007	(1)
6.	Oil Drain Valve	312-504-0185	(1)
7.	1/4 x 1 1/4 Key	199-NHNT-SE UND	(1)
8.	Crank Pulley	011-6-2780	(1)
9.	Exhaust Manifold Gasket	309-11060-7016	(2)
10.	Exhaust Manifold	152-603-MAN	(1)
11.	Catalytic Muffler	152-603-MUF	(1)
12.	Debris Screen Adapter	283-040-2250	(1)
13.	Air Filter Element	309-11013-7049	(1)
14.	Foam Pre Filter	309-11013-7046	(1)

D. L

li

•

•

•

F

•

•

•

•

•

•

•

•

•

E. A

The
the

This
diff
of a

uts

NOTES

to
le
it

ry

ibly

's

!

res
xle
are
7

;

m

NOTES

L
L
'
C
L

I. I

A. U
sch
All r
mai
folk
(Se

B. U
Ma
oil..
ada
just
up
guic
for.

C. I
all
i
t
a
s
a
s
r
I
t
a
(
z
i.
f
f
r
r
h
t
i.
e
L
L
S
C
r

NOTES

ng

r

,

or

e
re

ine

ill

if
re

,

ing



,

,

,

,

,

AZTEC PRODUCTS WARRANTY

Aztec Products, Inc. warrants its products to be free from defects in material and workmanship for a period of one year from the date of sale. All engines are warranted by the manufacturers (Honda or Kawasaki) for a period of two years when engine maintenance schedules are followed.

The warranty does not apply to damage or failure caused by abuse, misuse, neglect, disassembly, alteration, unauthorized modification or repair, lack of proper maintenance, theft or damage by freight carriers. The warranty applies to parts, labor, and ground freight only. Aztec is not liable for transportation to or from repair centers or travel for on-site repairs. Aztec Products, Inc. will not be liable for incidental or consequential damages arising from the use of any of its products, whether defective or not.

Aztec Products, Inc. agrees, at its discretion, to repair or replace at its own expense any product or part(s) which examination proves to be defective in workmanship or materials provided that the purchaser notifies Aztec Products, Inc. directly within the warranty period and follows the Return Goods Policy. Engine repairs may be performed at engine manufacturer's service centers. For your closest center you may call the following numbers:

Kawasaki 616-949-6500

Honda 800-426-7701

In order to obtain parts warranty, the following procedures must be followed:

- 1. Customer must call Aztec Products, Inc. for an RGA (Return Goods Authorization) Number.*
- 2. We maintain the serial number, date of shipment or sale, and customer name on each piece of equipment sold. If you were the purchaser, please reference that information on your request for replacement or repair. If you purchased the equipment through a distributor, please contact them first. If you are not satisfied, contact Aztec and give us the distributor name, purchase date, and the serial number of the product.*
- 3. The defective part must be returned via ground freight prepaid to Aztec Products, Inc. with an RGA number accompanied by a copy to the original purchase invoice. Aztec is not responsible for the cost of packaging inbound freight, nor inbound freight damage. Pack machine carefully.*
- 4. Only Aztec Products, Inc. or its authorized dealers may make warranty repairs on Aztec Products, Inc. products. Others do so at their own risk and expense.*
- 5. We also offer to do warranty related repairs free of charge at our facility. Arrangements must be made in advance as outlined above. We will not accept freight collect returns or returns that do not indicate the RGA number on the packing list.*

The need for proper maintenance and care for this product cannot be overstated. Poor maintenance, neglect or abuse can prove to be very expensive.

You have purchased a quality product. Each of its components has been tested and approved for use by Aztec Products, Inc. It is unlikely that you will ever have a warranty claim if you properly maintain your machine.

This warranty is non-transferable.

AZTEC PRODUCTS, INC.

201 Commerce Drive • Montgomeryville, PA 18936 • 800-331-1423 • Fax 215-393-4800



201 COMMERCE DRIVE • MONTGOMERYVILLE, PA 18936

215-393-4700 • 800-331-1423 • FAX 215-393-4800