

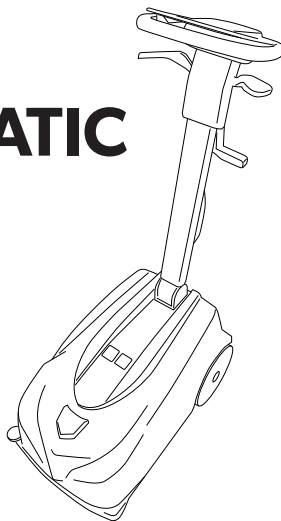

IPC

# CT5 LAVAMATIC



**(IT)** MANUALE ISTRUZIONI PER L'USO /  
**(EN)** OPERATOR'S MANUAL / **(FR)** MANUEL D'INSTRUCTIONS /  
**(DE)** BEDIENUNGSANLEITUNG / **(ES)** MANUAL DE INSTRUCCIONES /  
**(NO)** BRUKERHÅNDBOK / **(NL)** GEBRUIKERSHANDLEIDING /  
**(PT)** MANUAL DE UTILIZAÇÃO / **(SE)** INSTRUKTIONSBOK /  
**(RU)** РУКОВОДСТВО ОПЕРАТОРА /

Consultare attentamente questo manuale prima di procedere a qualsiasi intervento sulla macchina  
Read this manual carefully before carrying out any work on the machine  
Lire attentivement ce manuel avant toute intervention sur la machine  
Vorliegendes Handbuch vor jedem Eingriff an der Maschine aufmerksam durchlesen  
Consulte detenidamente este manual antes de llevar a cabo cualquier trabajo en la máquina  
Konsulter denne håndbogen nøye før du går i gang med noen som helst type inngrep på maskinen  
Raadpleeg deze handleiding aandachtig alvorens met enige werkzaamheid aan de machine te beginnen  
Consulte atentamente este manual antes de efectuar cualquier intervención na máquina  
Läs noggrant igenom denna handbok innan du utför något som helst ingrepp på maskinen  
Прочетете внимателно това ръководство, преди да започнете работа с машината

# (Translated instructions)

<b>IMPORTANT SAFETY PRECAUTIONS</b> .....	<b>2</b>
<b>MEANING OF SYMBOLS</b> .....	<b>7</b>
<b>TECHNICAL SPECIFICATIONS</b> .....	<b>8</b>
<b>MACHINE DIMENSIONS</b> .....	<b>9</b>
<b>GENERAL INFORMATION</b> .....	<b>10</b>
Purpose of this manual .....	10
Identifying the machine .....	10
Documentation/equipment accompanying the machine .....	10
<b>TECHNICAL INFORMATION</b> .....	<b>11</b>
General description .....	11
Parts of the machine .....	11
Accessories .....	12
<b>HANDLING AND INSTALLATION</b> .....	<b>12</b>
Lifting and transporting the palletized machine .....	12
Delivery checks .....	12
Unpacking .....	12
Selection of parking position .....	13
Lifting and transporting the machine .....	13
Transport on wheels .....	13
Winding and unwinding the power cable (mains powered version) .....	14
Adjusting the handle rake angle .....	14
Fitting the brush/pad driver .....	14
Brush/pad driver release .....	14
Battery: preparation / installation / recharging .....	14
Battery: removal .....	15
Battery: disposal .....	15
<b>PRACTICAL GUIDE FOR THE OPERATOR</b> .....	<b>16</b>
Preparing the machine for work .....	16
Controls .....	17
Working .....	18
Removal of dirty water tank lid .....	19
Installation of dirty water tank lid .....	19
Filling the water/detergent tank .....	19
Emptying the water/detergent tank .....	19
Emptying the dirty water tank .....	20
Drive adjustment .....	20
<b>PERIODS OF INACTIVITY</b> .....	<b>21</b>
<b>MAINTENANCE INSTRUCTIONS</b> .....	<b>21</b>
Maintenance - General rules .....	21
Cleaning the suction float .....	22
Cleaning the water/detergent tank filter .....	22
Cleaning the suction filter .....	22
Cleaning the front squeegee suction hose .....	22
Cleaning the rear squeegee suction hose .....	22
Cleaning the diverter valve .....	23
Cleaning the squeegee .....	23
Squeegee adjustment .....	23
Replacing the brush .....	24
<b>TROUBLESHOOTING</b> .....	<b>25</b>
<b>ALARMS</b> .....	<b>26</b>

# **IMPORTANT SAFETY** **PRECAUTIONS**

- Read the operating instructions carefully before using the machine for the first time.
- Keep the instructions handy, in a safe place. They constitute an important component of the machine and must be handed over together with the machine in the event of its being sold or transferred.

## **WARNINGS**

**Whilst the machine is manufactured to a high standard of safety, safety in operation can be guaranteed only by complying with the instructions in this manual.**

### Correct use

The machine is not designed for use by persons (including children) with reduced physical, sensory or mental capabilities, or lack of experience and knowledge.

Use of the machine as a toy is prohibited: make certain this does not happen.

Children should be supervised to ensure they do not play with the machine.

Cleaning and maintenance of the machine must in any event be carried out exclusively by adults in full possession of the requisite mental and physical faculties.

The machine is designed to operate in temperatures between +4°C and +40°C. It can be stored in temperatures between +0°C and +50°C when not in use.

The machine is designed to operate at relative humidity levels between 30% and 95%.

The machine can operate at altitudes up to 2000 m maximum.

This machine is intended for commercial use, for example in hotels, schools, hospitals, factories, shops, offices and business premises generally.

The machine must only be used indoors.

The machine must be kept indoors at all times.

Do not use the machine on surfaces with a gradient steeper than 2%.

### **Danger of electric shock**

- Switch off the machine, and remove the plug from the mains socket (mains powered version), or disconnect the battery (battery powered version), before commencing any cleaning or maintenance work.
- When using the mains powered version, turn off at the main switch and pull the plug from the power socket before leaving the machine unattended.
- When using the mains powered version, do not pull the plug from the socket by tugging the power cable. Take hold of the plug directly, not the cable, before pulling.
- When using the mains powered version, never pull or move the machine around by dragging the power cable.
- When using the mains powered version, never use the power cable as a handle, and ensure it is not pinched by a closed door or pulled over sharp edges or around corners.
- When using the mains powered version, do not run the machine over the power cable.
- When using the mains powered version, keep the power cable well away from heated surfaces.
- When using the mains powered version, do not use adaptors on the mains plug.
- When using the mains powered version, take care to prevent the brush from coming into contact with the power cable.
- When using the mains powered version, inspect the power cable periodically and if damaged, do not on any account use the machine until the cable has been replaced; contact a specialist technician approved by IP Cleaning or take the machine to any IP Cleaning service centre.
- When using the mains powered version, never touch the machine with wet hands.
- If the machine is not working as it should, or if it has suffered a

heavy impact, or been dropped, damaged, left out in the open or fallen into water, do not use it until it has been checked out; contact a specialist technician approved by IP Cleaning or take the machine to any IP Cleaning service centre.

- Battery charger: inspect the battery charge cable periodically for possible damage. If damage has occurred, do not use the battery charger until the cable has been replaced; contact a specialist technician approved by IP Cleaning or take the machine to any IP Cleaning service centre.
- Make certain the power sockets used for mains powered models and battery chargers are properly earthed and protected by a 2-pole thermal magnetic switch with differential circuit-breaker:
  - rated current 10-16A
  - $I_{\Delta n}$  differential current: 0.03A
  - $I_{cn}$  breaking capacity: 6000 A
  - AC differential breaker trip
- This machine (mains powered model) must be earthed. In the event of a malfunction or failure, the earth connection provides the path of least resistance for electrical current, reducing the risk of electric shock. Mains powered versions come with a three-core cable and a three-pin plug for connection to a suitable earthed power socket. The earth wire is yellow and green. Never connect this wire to anything other than the earth terminal of the socket. The plug must be inserted into a suitable socket, correctly installed and wired in accordance with local building regulations. Incorrect wiring or failure to connect the earth wire of the machine may lead to the risk of electric shock. If in doubt about the proper earthing of the power socket, have it checked by a qualified electrician. Do not tamper with the plug fitted to the machine, and use only sockets compatible with this same plug. If the power socket needs to be replaced, have the job done by a professional electrician.
- Do not clean the machine with water or a high pressure hose.

- Never attempt to carry out repairs on the machine. Should the need arise, contact a specialist technician approved by IP Cleaning or take the machine to any IP Cleaning service centre.

### **Fire risk**

- Do not use the machine to clean up flammable or combustible liquids such as petrol, and do not operate the machine in areas where these liquids may be present.
- Do not use the machine to pick up burning or smoking material like cigarettes, matches or hot ashes.
- Do not position the machine on or in close proximity to a cooker or any other hot surface, as the battery could catch fire or explode.

### **Risk of injury**

- Use only batteries supplied by the manufacturer ( BAAC00192 or BAAC00193 code), as other types of battery could explode, causing injury to persons and damage to property.
- Keep hair, loose garments, fingers and all other parts of the body well clear of slots and moving parts.
- Avoid any contact with moving parts of the machine (brushes and pad drivers).
- Take particular care when cleaning steps and stairs.
- Do not use the machine if plastic parts are damaged as a result of a fall or impact; avoid contact with broken pieces and sharp edges.
- Never use detergents other than those specified. Follow the instructions on the relative safety data sheet. Always keep detergents out of the reach of children. In the event of detergent making contact with the eyes or the skin, wash immediately and copiously with water, and if swallowed, consult a doctor immediately.















### **Risk of damage caused by improper use**

- When recharging the battery, use only the battery charger (BACA00263 code), supplied by the manufacturer.
- Use only original spare parts supplied by the manufacturer.
- The mains powered machine requires an alternating current

electricity supply and must be plugged into a power socket installed by a professional electrician.

- Make certain that the electrical specifications of the machine (voltage, frequency and power consumption) indicated on the data plate are compatible with those of the mains electricity supply.
- Do not insert objects of any kind into the ventilation slots. Do not operate the machine with blocked ventilation slots. Remove all dust, dirt, hair and debris that might be blocking the air flow.

## MEANING OF SYMBOLS

	NEGOTIABLE GRADIENT
	OPERATOR MANUAL, INSTRUCTIONS FOR USE
	READ THE MANUAL BEFORE USING THE MACHINE
	DIRECT CURRENT
	CLASS III APPLIANCE. AN APPLIANCE IS IDENTIFIED AS CLASS III WHEN ITS EXPLOSION-PROOF PROTECTION IS BASED ON THE FACT THAT THERE ARE NO VOLTAGES HIGHER THAN THE ULTRA-LOW SAFETY EXTRA-LOW VOLTAGE (SELV). THIS MEANS IN PRACTICE THAT THE APPLIANCE IS POWERED BY A BATTERY OR A SELV TRANSFORMER.
	EARTH SYMBOL, IDENTIFIES ANY TERMINAL INTENDED FOR CONNECTION TO AN EXTERNAL EARTH CONDUCTOR AND PROTECTING AGAINST ELECTRIC SHOCK IN THE EVENT OF A MALFUNCTION.
	BRUSHES ON/OFF.
	DETERGENT SOLUTION FLOW ON/OFF AND REGULATION.
	SUCTION ON/OFF.
	"ECO" OPERATING MODE.
	MACHINE ON/OFF.
	SPECIAL WASTE. DO NOT DISPOSE OF AS NORMAL WASTE.
	CAUTION, RISK OF ABRASION.
	MINIMUM AND MAXIMUM TEMPERATURE OF LIQUID IN TANK.



## TECHNICAL SPECIFICATIONS

		B	230 V AC	115 V AC
Brush diameter	mm	280	280	280
	inches	11,02		
Brush rotation speed	rpm	160		
	rpm			
Brush motor power	W	100		
	HP	0,134		
Maximum brush pressure	g/cm <sup>2</sup>	35	35	35
	kPa	3,4	3,4	3,4
Suction motor power	W	140		
	HP	0,187		
Solution tank	l	4,8	4,8	4,8
	galls.	1,26	1,26	1,26
Dirty water tank	l	5	5	5
	galls.	1,32	1,32	1,32
Squeegee width	mm	360-390	360-390	360-390
	inches	14.17-15.35	14.17-15.35	14.17-15.35
Rear wheel diameter	mm	200	200	200
	inches	7,87	7,87	7,87
Cleaning width	mm	280	280	280
	inches	11,02	11,02	11,02
Cleaning capacity per hour	m <sup>2</sup> /h	650		
	ft <sup>2</sup> /h	6996,5		
Maximum slope	%	2	2	2
Maximum water and detergent temperature	°C	40	40	40
Degree of protection	IP	IPX3		
Power supply voltage at battery charger input	Vac	100-240		
Power supply frequency at battery charger input	Hz	50-60		
Current draw at battery charger input	A	1,8		
Power supply voltage at battery charger output	Vcc	42		
Maximum scrubber dryer recharge current	A	2		
Number of batteries	no.	1	/	/
Battery voltage	V	36	/	/
Gross weight (GVW)	kg	27	27	27
	lbs	59,52		

Transported weight	kg	7	7	7
	lbs	15,43		
Machine dimensions (X, Y, Z)	mm	X = 604 X1 = 770 Y = 399 Y1 = 1049 Z = 412.5		
	inches	X = 23.77 X1 = 30.31 Y = 15.7 Y1 = 41.29 Z = 16.24		
Packed size (length, width, height)	mm	800x400x470		
	inches	31,5x15,8x18,5		
Sound pressure	LpA (dB)	63,5		
Measurement uncertainty	K (dB)	3		
Vibration level (hand)	HAV m/sec <sup>2</sup>	1		
Measurement uncertainty, k	m/sec <sup>2</sup>	0,5		

Gross weight (GVW): maximum permissible weight with the machine fully loaded and ready for use. The gross weight of the machine comprises the detergent tank filled with clean water, the dirty water tank, empty, the largest recommended battery pack and all accessories, namely cables, hoses, detergents and brushes.

Transported weight: the weight of the machine in transit, which includes batteries and clean water. Data subject to variation without prior warning.

## **MACHINE DIMENSIONS**

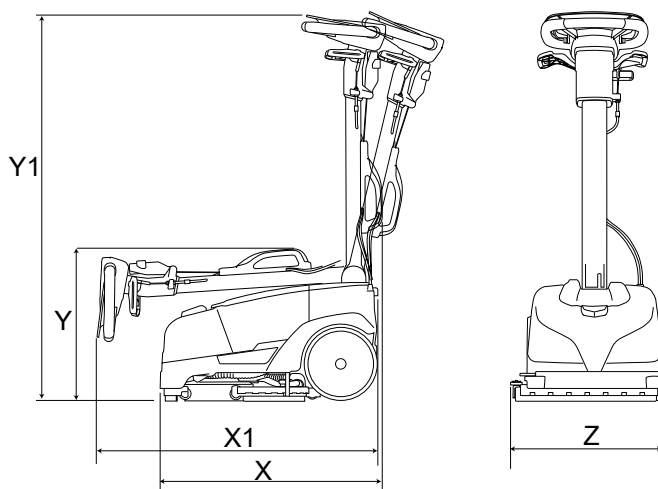

X-Y-Z: [See "TECHNICAL SPECIFICATIONS" table](#)

# **GENERAL INFORMATION**

## **Purpose of this manual**

This manual has been written by the Manufacturer and is an integral part of the equipment package making up the **machine**<sup>1</sup>.

It defines the purpose for which the machine has been designed and built and contains all the information needed by **operators**<sup>2</sup>.

In addition to this manual, containing information intended essentially for users, other publications are available providing specific information for technicians entrusted with **maintenance**<sup>3</sup>.

The terms "right" and "left", "clockwise" and "anti-clockwise" refer to the forward movement of the machine.

Constant compliance with the instructions provided in this manual guarantees the safety of the operator and the machine, ensures low running costs and high quality results and extends the working life of the machine. Failure to follow these instructions may lead to injury to the operator or damage to the machine, floor and environment.

Consult the table of contents at the beginning of the manual to find the section of interest without delay.

Parts of the text requiring special attention are printed in bold and preceded by the symbols illustrated and described here.

### **! DANGER**

**Indicates the need for attention in order to avoid a series of consequences which could cause death or serious injury to personnel.**

### **! WARNING**

**Indicates the need for attention in order to avoid a series of consequences which could cause injury to personnel or damage to the machine or work environment or financial loss.**

### **! INFORMATION**

#### **Important information**

In line with the company's policy of constant product development and updating, the Manufacturer reserves the right to make modifications without prior notice.

Whilst the machine in your possession may differ appreciably from the illustrations in this document, the safety and the information regarding the product are guaranteed reliable.

## **Identifying the machine**

The nameplate provides the following information:

- Model
- Battery voltage.
- Rated current draw.
- Serial number.
- Year of manufacture.
- IP degree of protection.
- Gross weight.
- Maximum negotiable gradient
- Name of manufacturer.

## **Documentation/equipment accompanying the machine**

- Operator's manual
- Battery charger manual;
- Certificate of warranty;
- CE certificate of conformity.

<sup>1</sup> The definition "machine" replaces the trade name "CTS" of the product to which this manual refers.

<sup>2</sup> Persons responsible for using the machine without performing any operations requiring precise technical skills.

<sup>3</sup> Persons with experience, technical training and a knowledge of legislation and standards, able to perform all the necessary operations and to recognise and avoid possible risks in handling, installation, use and maintenance of this machine.

## TECHNICAL INFORMATION

### General description

This machine is a scrubber dryer for sweeping, washing and drying flat, horizontal, smooth or moderately rough, uniformly structured and obstacle-free floors in civil and industrial premises.

The scrubber dryer spreads a solution of water and detergent in the correct concentration on the floor and then scrubs it to remove the dirt. By carefully choosing the detergent and brushes (or abrasive disks) from the wide range of accessories available, the machine can be adapted to a wide range of combinations of types of floor and dirt.

The machine incorporates a wet vacuuming system which dries the floor immediately after washing. The drying action is produced by the suction motor, which generates a partial vacuum in the dirty water tank. Squeegees mounted beneath the tank are designed to collect the film of dirty water with the machine moving in both forward and reverse directions.

### Parts of the machine

Below is the description of the machine main parts:

- The water/detergent tank (fig. 1, ref. 1) contains and carries the mixture of clean water and cleaning product.
- The dirty water tank (fig. 1, ref. 2) collects the dirty water picked up from the floor after washing;
- Control panel (fig. 1, ref. 3).
- Head assembly (fig. 1, ref. 4), the main element comprises the brush that spreads the detergent solution over the floor and washes the surface, bringing about the removal of the dirt.
- Front squeegee assembly (fig. 1, ref. 5), which wipes and dries the floor when the machine is pulled toward the operator.
- Rear squeegee assembly (fig. 1, ref. 6), which wipes and dries the floor when the machine is pushed forward by the operator.
- Battery (fig. 1, ref. 7).

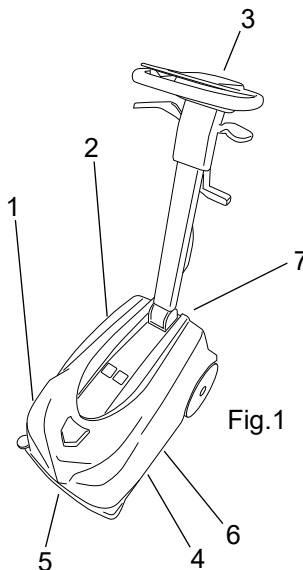

Fig.1

## Accessories

- Soft and hard brushes, abrasive pads.
- Pad Holder.
- Standard battery (BAAC00192 code).
- Uprated battery (BAAC00193 code).
- Battery charger (BACA00263 code).

## **HANDLING AND INSTALLATION**

### **Lifting and transporting the palletized machine**

The machine comes packed in a cardboard box by the manufacturer.

Handle with care to avoid impact and ensure the machine is not overturned.

### **Delivery checks**

On taking delivery of the machine, check carefully that the packing and machine it contains are both intact.

### **Unpacking**

When unpacking the machine, proceed as follows:

- Cut and remove the plastic straps using scissors or nippers;
- Open the box;
- Remove the following items from the packaging:
  - operating and maintenance manual, declaration of conformity, certificate of warranty;
  - battery charger manual;
  - bumper wheel;
  - front squeegee:
  - brush;
  - battery charger.
- Lift the machine out of the box by the handle (fig. 2, ref. 1) and set it down on the floor.
- Pull the handle up at right angles to the machine, referring to the section “Adjusting the handle rake angle”
- Remove the dirty water tank and the detergent tank and set them on the floor, referring to the section “Emptying the water/detergent tank” and “Emptying the dirty water tank”.
- Tilt the machine backwards and rest the handle on the floor.
- Cut the ties applied to the rear squeegee.
- Install the front squeegee (fig. 2A, ref. 1).
- Install the bumper wheel (fig. 2B, ref. 1).

### **! WARNING**

**Keep the packaging materials and store in a safe place: in the event of relocation or shipment to authorized workshops, the original packaging will ensure that the machine and battery pack remain undamaged.**

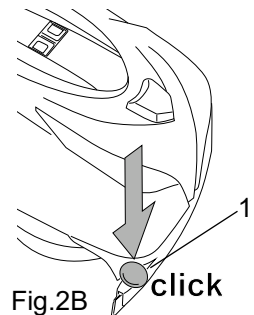
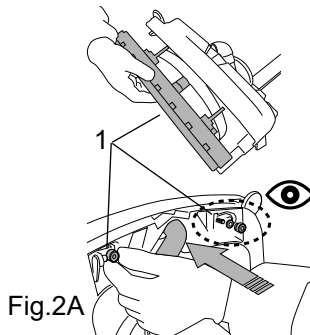
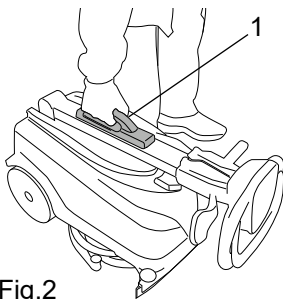

## Selection of parking position

### ! DANGER

The machine must be unplugged from the power socket (mains powered model).

### ! WARNING

Before placing the machine in the parking position, empty the detergent tank and the dirty water tank, referring to the relative sections “Emptying the water/detergent tank” and “Emptying the dirty water tank”.

### ! WARNING

The machine must always be parked standing on end (vertical); if left in the normal operating position (horizontal), the weight of the machine can cause the bristles of the brush, and the squeegee blades, to bend out of shape.

- Turn off the machine off at the main switch (fig. 3, ref. 1).
- Wind the power cable around the storage hooks (mains powered model), referring to the section “Winding and unwinding the power cable (mains powered model)”.
- Raise the squeegee by operating the lever (fig. 3, ref. 2).
- Fold the handle fully forward toward the head assembly, referring to the section “Adjusting the handle rake angle”
- Pull the machine up into the vertical position (fig. 4).
- Wipe dry the front squeegee, rear squeegee and brush with a cloth.

## Lifting and transporting the machine

### ! DANGER

Risk of injury if handle is not properly locked in position.

### ! WARNING

Empty the detergent tank and the dirty water tank, referring to the relative sections “Emptying the water/detergent tank” and “Emptying the dirty water tank”.

- Turn off the machine off at the main switch (fig. 6, ref. 1).
- Unplug the machine from the power socket (mains powered model).
- Wind the power cable around the storage hooks (mains powered model), referring to the section “Winding and unwinding the power cable (mains powered model)”.
- Raise the squeegee by operating the lever (fig. 5, ref. 1).
- Fold the handle fully forward toward the head assembly.
- Lift the machine by the grip on the shaft of the handle (fig. 6, ref. 2).

## Transport on wheels

The machine can be moved from one place to another on its wheels and steered in all directions:

- Set the angle of the handle so that it stands perpendicular to the machine.

Tilt the machine backwards (fig. 7), and it can be wheeled backwards or forwards as required.

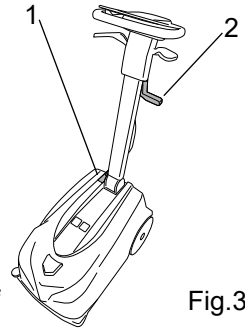

Fig.3

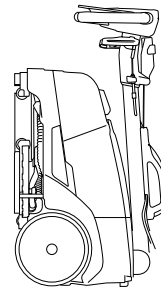

Fig.4

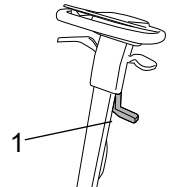

Fig.5

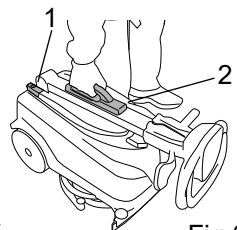

Fig.6

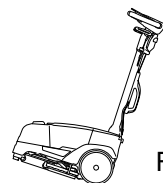

Fig.7

## Winding and unwinding the power cable (mains powered version)

### ! WARNING

Unplug the machine from the power socket before winding the cable.

### ! WARNING

Check that no damage occurs either to the machine or to the power cable during the winding procedure.

When the machine is not in use, the power cable must be wound around the storage hooks (fig. 8)

When the machine is in use, the power cable must be unwound completely.

## Adjusting the handle rake angle

Pull the adjustment lever (fig. 9, ref. 1) and hold, then set the handle at the desired angle. Releasing the lever, the handle will remain locked in the position selected.

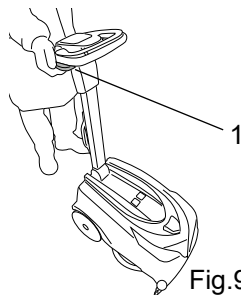

Fig.9

## Fitting the brush/pad driver

- Plug the machine into the power socket (mains powered model).
- Press the main switch (fig. 10, ref. 1) to turn on the machine.
- Press the brush control button (fig. 11, ref. 1).
- Rest the brush on the floor in front of the machine.
- Pull back on the handle to elevate the front part of the machine, position the brush cowling directly over the brush, and proceed to lower the machine (fig. 12).
- Jog the brush control lever (fig. 11, ref. 2) repeatedly; this will enable the brush to engage automatically with the hub of the flange. If the operation is not successful, reposition the machine as before, then repeat the steps of aligning the brush and jogging the control lever.



Fig.10

## Brush/pad driver release

- Plug the machine into the power socket (mains powered model).
- Press the main switch (fig. 10, ref. 1) to turn on the machine.
- Pull back on the handle to elevate the front part of the machine (fig. 12).
- Press the brush control button (fig. 11, ref. 1) and hold for 3 seconds; the machine will activate the brush release mechanism automatically.

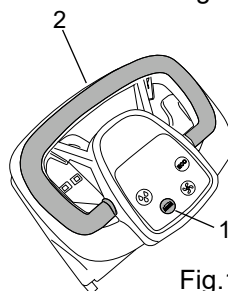

Fig.11

## Battery: preparation / installation / recharging

### ! DANGER

When installing or carrying out any kind of maintenance on the battery, keep a safe distance from naked flames and heat sources, do not short-circuit the battery poles, avoid creating sparks and do not smoke.

### ! DANGER

Use only batteries supplied by the manufacturer of the machine: code BAAC00192 or BAAC00193.

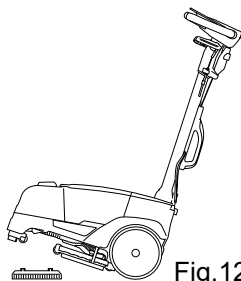

Fig.12

### **! WARNING**

**When recharging the battery, use only the battery charger (BACA00263 code), supplied by the manufacturer of the machine.**

Should it become necessary to replace the battery, contact a specialist technician approved by IP Cleaning or take the machine to any IP Cleaning service centre.

The battery is a sealed unit and guaranteed safe under normal circumstances; in the unlikely event of fluid leaking from the battery, do not touch the fluid and be sure to take the following precautions:

- Contact with the skin can cause irritation; wash with soap and water.
- Inhalation of vapours can cause irritation to the airways; stay out in the open air and consult a doctor.
- Contact with the eyes can cause irritation; flood the eyes with water immediately and thoroughly for at least 15 minutes, and consult a doctor.

The battery used in this machine could pose a risk of fire or chemical burns if treated carelessly or improperly; it must not be dismantled, and should be kept well clear of children.

Whilst the battery will normally come fully charged and ready for use, it is good policy nonetheless to run a recharge cycle before the machine is put into service, proceeding as indicated below:

- Insert the jack plug of the battery charger into the socket on the battery (fig. 13).
- Plug the battery charger into the mains power socket.
- Wait for the recharge cycle to finish; the Led on the battery charger will turn green.
- Disconnect the battery charger from the power socket and from the battery.

### **Battery: removal**

#### **! DANGER**

**When removing the battery from the machine, keep a safe distance from naked flames and heat sources, do not short-circuit the battery poles, avoid creating sparks and do not smoke.**

#### **! DANGER**

**The battery can be removed only with the machine switched off.**

Press the two sliding release catches and remove the battery from its housing (fig. 13A, ref. 1).

### **Battery: disposal**

Ensure the battery is disposed of correctly, in compliance with current local environmental regulations. Do not throw the battery away as household refuse.

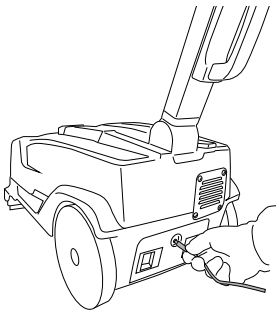

Fig.13

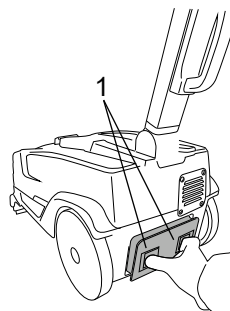

Fig.13A



# **PRACTICAL GUIDE FOR THE OPERATOR**

## **! INFORMATION**

If the machine is being used by an operator for the first time, it should be tried out initially in a spacious and obstacle-free area to acquire the necessary familiarity with the functions and controls.

## **! WARNING**

To avoid damaging the surface of the floor being cleaned, do not leave the brushes rotating with the machine stationary.

## **! WARNING**

Always dilute the detergent according to the manufacturer's instructions. Do not use sodium hypochlorite (bleach) or other oxidants, particularly in strong concentrations. Do not use solvents or hydrocarbons. The water and detergent temperature must not exceed the maximum indicated in the "Technical specifications". There must be no sand and/or other impurities in the solution.

## **! INFORMATION**

The machine has been designed for use with low-foam biodegradable detergents made specifically for scrubber dryers.

For a complete and up-to-date list of detergents and chemicals available, contact the manufacturer

## **! INFORMATION**

Use only products suitable for the floor and dirt to be removed.

Follow the safety regulations on the use of detergents given in the section "Risk of injury".

## **! DANGER**

Before starting work, put on overalls, non-slip shoes, gloves and all other personal protection devices recommended by the supplier of the detergent used or appropriate for the type of work environment.

## **Preparing the machine for work**

Proceed as follows before starting work.

- Check the battery charge indicator lights to ensure that the battery is fully charged (battery powered model), and if not, run the recharge cycle, referring to the section "Battery: preparation / installation / recharging".
- Unwind the power cable from the storage hooks (mains powered model), referring to the section "Winding and unwinding the power cable".
- Plug the machine into the power socket (mains powered model).
- Make certain that the dirty water tank is empty, and if not, empty it, referring to the section "Emptying the dirty water tank".
- Make certain that the detergent solution tank is full, and if not, proceed to fill it, referring to the section "Filling the water/detergent tank".
- Adjust the position of the handle, referring to the section "Adjusting the handle rake angle".
- Fit the brush, referring to the section "Fitting the brush/pad driver".

## Controls

The machine has the following controls and indicator lights:

- Main switch (fig. 14, ref. 1): connects and disconnects electrical power to and from all functions of the machine.
- Power on light (mains powered model) (fig. x, ref. x): colour yellow, indicates that the power cable of the machine is connected to the mains supply and the main switch has been depressed (fig. 14, ref. 1).
- Battery charge indicator (battery powered models only) (fig. 15, ref. 1): consists of 3 Leds, red, yellow and green, showing the battery charge level. Possible charge level indications:
  - Green Led alight: battery charge > 30.0 %.
  - Yellow Led alight: battery charge between 10% and 30%.
  - Red Led alight: battery charge between 5% and 10%.
  - Red Led blinking: battery charge < 5%, battery completely flat; after a few seconds the brush motor and suction motor will be shut off;
- Brush control button (fig. 15, ref. 2): enables (Led alight) and disables (Led dark) operation of the “Brush” function; the brush does not start rotating until the “Brush control lever”(fig. 15, ref. 2) is operated.

### ! INFORMATION

**Pressing the brush control button also has the effect of automatically enabling the suction and detergent solution flow functions, which can then be controlled and adjusted by way of the respective single buttons on the console.**

- Suction control button (fig. 15, ref. 3): switches on (“Led alight”) and switches off (“Led dark”) the suction motor, which generates the vacuum needed to dry the floor after scrubbing. The motor comes into operation only when activated by way of the “Brush control lever”.
- Detergent flow button (fig.15, ref. 5): enables (Led alight) and disables (Led dark) the flow of detergent solution, with three levels of delivery available. Flow is enabled only with the brush in operation.
- ECO button (fig.15, ref. 4): enables (Led alight) and disables (Led dark) ECO operating mode.

### ! INFORMATION

**In ECO operating mode, the power of the brush motor and suction motor is reduced automatically and the flow of detergent solution defaults to delivery level 1.**

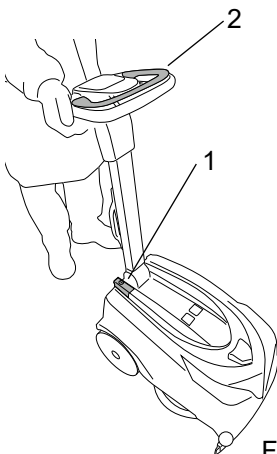

Fig.14

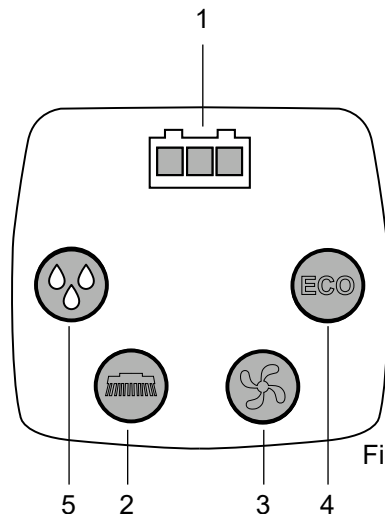

Fig.15

## Working

- Press the main switch (fig. 16, ref. 1).
- Press the brush button or the ECO button (fig. 17, ref. 1), in addition to activating the brush, this will also enable the vacuum function and the flow of detergent solution.
- Lower the squeegee by operating the lever (fig. 16, ref. 2).
- Depress the brush control lever (fig. 16, ref. 3).
- Begin working.

### ! INFORMATION

**This machine can dry the floor moving both forward and in reverse. To operate the drying function in reverse, pull the lever upwards (fig. 18, ref. 1).**

- When work is in progress, check the thoroughness of the wash and regulate the flow of detergent solution accordingly, with the relative button (fig. 17, ref. 3).

### ! INFORMATION

**Check periodically that the detergent solution is reaching the brush, and take care to fill the tank when empty.**

### ! WARNING

**Should the red Led of the battery charge indicator light up when work is in progress, this means that the battery is almost out of power, and after a few seconds the brush and vacuum functions will shut off automatically. Proceed to recharge the battery, referring to the section “Battery: preparation / installation / recharging”.**

In cases where floors are soiled with particularly stubborn dirt, scrubbing and drying operations can be performed in two separate stages.

Prewashing with brushes or pads:

- Plug the machine into the power socket (mains powered model).
- Raise the squeegee by operating the lever (fig. 16, ref. 2).
- Press the main switch (fig. 16, ref. 1).
- Press the brush control button (fig. 17, ref. 1).
- Switch off the vacuum function by pressing the suction control button (fig. 17, ref. 2).
- Depress the brush control lever (fig. 16, ref. 3).
- When scrubbing particularly dirty areas, give the detergent sufficient time to perform its chemical action of detaching and suspending the dirt in the film of water, and allow the brushes time to exert an effective mechanical action.

Drying

- Lower the squeegee by operating the lever (fig. 16, ref. 2).
- Press the suction control button to activate the vacuum function, and pass over the area washed previously: this will produce an effect similar to a thorough scrub, with the result that subsequent routine maintenance work on the floor will be less time-consuming.

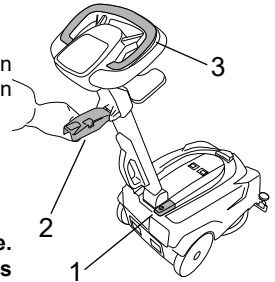

Fig.16

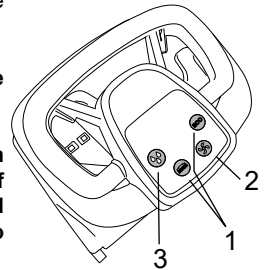

Fig.17

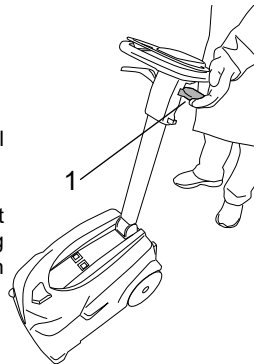

Fig.18

## Removal of dirty water tank lid

- Release the lid of the dirty water tank by pressing the two sliding catches toward one another (fig. 19, ref. 1).
- Lift off the lid.

## Installation of dirty water tank lid

### ! INFORMATION

**INCORRECT** positioning of the lid on the dirty water tank will cause the machine to malfunction when the floor is being dried.

- Place the lid on the tank.
- Apply downward pressure to the lid, sufficient to make certain that the two sliding release catches spring outwards and engage with the top of the dirty water tank (Fig.20).

### ! INFORMATION

The lid is correctly installed when the **RED** background presented by the recesses of the two catches can **NOT** be seen (fig. 20).

## Filling the water/detergent tank

### ! DANGER

**Unplug the machine from the power socket (mains powered model).**

### ! INFORMATION

**Remember to empty the dirty water tank every time the clean water and detergent tank is filled.**

The tank can be filled in two different ways:

Tank installed on the machine:

- Turn off the machine at the main switch.
- Remove the cap of the detergent tank (fig.21, ref. 1).
- Fill the tank.

Tank removed from the machine:

- Turn off the machine off at the main switch.
- Press in the two lateral tank retaining catches (fig. 22, ref. 1), separate the dirty water tank from the frame and set it down on the floor.
- Remove the cap of the detergent tank.
- Separate the detergent tank from the frame.
- Fill the tank (fig. 23).

## Emptying the water/detergent tank

### ! DANGER

**Unplug the machine from the power socket (mains powered model).**

The tank can be emptied by proceeding as follows:

- Turn off the machine off at the main switch.
- Take the machine to the designated disposal area.
- Press in the two lateral tank retaining catches (fig. 22, ref. 1), separate the dirty water tank from the frame and set it down on the floor.
- Separate the detergent tank from the frame.
- Remove the cap of the detergent tank.
- Empty the contents of the tank by way of the front opening (fig. 24).

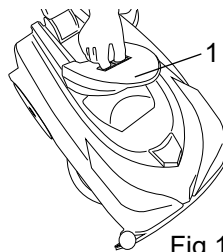

Fig.19

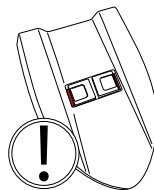

Fig.20

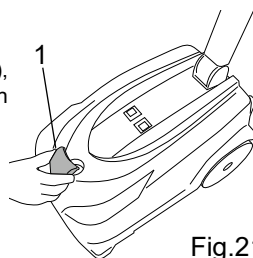
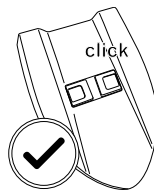

Fig.21

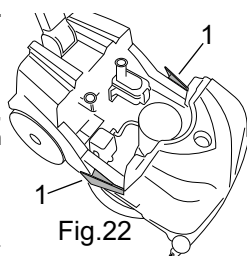

Fig.22

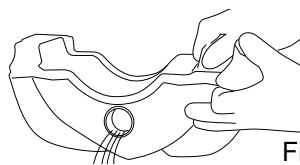

Fig.24



Fig.23

## Emptying the dirty water tank

**! DANGER**

### Unplug the machine from the power socket (mains powered model).

An automatic float-controlled shut-off device mounted to the lid of the dirty water tank is designed to inhibit further operation of the vacuuming system when the tank is full. It is possible to recognize when the vacuuming system has been shut off, as the suction motor will suddenly become noisier in operation, and the floor will not dry as expected. In this situation, the operator must stop the machine and empty the dirty water tank, proceeding as follows:

- Turn off the machine off at the main switch.
- Take the machine to the designated disposal area.
- Press in the two lateral tank retaining catches (fig. 25, ref. 1), and separate the dirty water tank from the frame.
- Remove the cap of the dirty water tank (fig.26, ref. 1).
- Empty the tank (fig. 27).

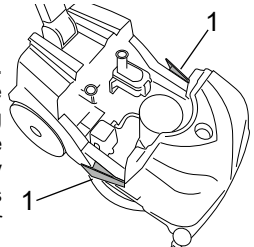

Fig.25

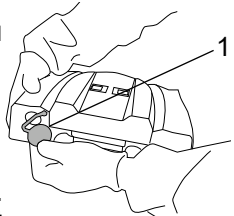

Fig.26

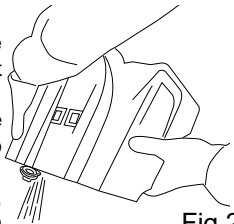

Fig.27

## Drive adjustment

**! DANGER**

### Unplug the machine from the power socket (mains powered model).

The machine is equipped with a special mechanical drive device that exploits the friction created between brush and floor to generate forward movement.

The driving force produced by the device can be varied by turning the relative knob (fig. 28, ref. 1), which presents two sectors of different colour, one green and the other yellow:

- turning the knob to the position that exposes the green sector, the driving force is increased and the machine will tend as a result to deviate from a straight line.
- turning the knob to the position that exposes the yellow sector, the driving force is attenuated and the machine will advance in a straight line.

To make the adjustment, proceed as follows:

- Turn off the machine at the main switch.
- Remove the dirty water tank and the detergent tank and set them on the floor, referring to the section "Emptying the water/detergent tank" and "Emptying the dirty water tank".
- Elevate the brush/motor by taking up the weight with one hand, and with the other hand, turn the knob (fig. 28, ref. 1) to the position desired.

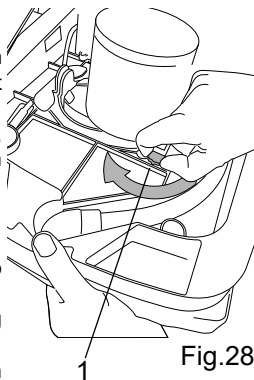

Fig.28

## Finishing work

- Turn off the machine at the main switch.
- Empty the dirty water tank and rinse with clean water, referring to the section "Emptying the dirty water tank".
- Empty the detergent solution tank, referring to the section "Emptying the water/detergent tank".
- Stow the machine in the parking position, referring to the section "Selection of parking position".

## **PERIODS OF INACTIVITY**

Proceed as follows to prepare the machine for extended periods of inactivity:

- Remove the battery from the machine, referring to the section “Battery: removal” and recharge it fully, referring to the section “Battery: preparation / installation / recharging”. The battery should also be recharged regularly when the machine is not in use, so as to keep it constantly at the maximum charge level.
- Clean the squeegee blades with a moist cloth, referring to the section “Cleaning the squeegees”.
- Open up and clean the chamber of the diverter valve, referring to the section “Cleaning the diverter valve”.
- Detach and clean the suction hoses of the squeegees, referring to the section “Cleaning the front squeegee suction hose” and “Cleaning the rear squeegee suction hose”.
- Make certain the tanks have been emptied completely and are perfectly clean, referring to the section “Emptying the dirty water tank” and “Emptying the water/detergent tank”.
- Stow the machine in the parking position, referring to the section “Selection of parking position”.

## **MAINTENANCE INSTRUCTIONS**

### **! DANGER**

**Never perform any maintenance operations on the machine without first unplugging it from the mains socket (mains powered models) or removing the battery pack (battery powered models).**

### **! DANGER**

**In the case of mains powered models, the operator must be able to verify from any position occupied that the machine remains unplugged from the mains socket while maintenance is being carried out.**

### **! WARNING**

**Before proceeding with any maintenance operation on the machine, always be sure to empty the detergent tank and the dirty water tank, referring to the relative sections “Emptying the water/detergent tank” and “Emptying the dirty water tank”.**

### **! INFORMATION**

**Maintenance operations involving the electrical system, and in any event all servicing or repair operations not explicitly described in this manual, must be entrusted to a specialist technician approved by IP Cleaning or carried out at an IP Cleaning service centre, in accordance with current safety regulations.**

### **! INFORMATION**

**Ensure the machine undergoes regular maintenance, so that it will always deliver optimum performance.**

### **! INFORMATION**

**Do not clean seals with ethyl alcohol.**

This chapter describes how maintenance is carried out.

### **Maintenance - General rules**

When cleaning the machine, observe the following precautions.

- Avoid the use of high pressure washers. Water could penetrate the electrical compartment or the motors, leading to damage or the risk of short circuit.
- Do not use steam, as the heat generated could cause plastic parts to lose their shape.
- Do not use solvents or hydrocarbon based products. These can damage the cowling and rubber components.

## Cleaning the suction float

- Release the lid of the dirty water tank.
- Turn the lid over and check that the floats can move freely (fig. 29, ref. 1).
- Clean the seals with a moist cloth (fig. 29, ref. 2).
- Refit the lid.

### ! INFORMATION

Do not clean seals with ethyl alcohol.

## Cleaning the water/detergent tank filter

- Remove the dirty water tank and the detergent tank and set them on the floor, referring to the section “Emptying the water/detergent tank” and “Emptying the dirty water tank”.
- Remove the filter and wash with water (fig. 30, ref. 1).

## Cleaning the suction filter

- Remove the dirty water tank from the machine and set it on the floor, referring to the section “Emptying the dirty water tank”.
- Remove the filter and wash with water (fig. 30, ref. 2).

## Cleaning the front squeegee suction hose

- Remove the dirty water tank and the detergent tank and set them on the floor, referring to the section “Emptying the water/detergent tank” and “Emptying the dirty water tank”.
- Detach the hose from the diverter valve (fig. 31, ref. 1) and from the front squeegee (fig. 29, ref. 2).
- Wash the hose by directing water into the bore (fig. 32)
- Reattach the hose.

## Cleaning the rear squeegee suction hose

- Remove the dirty water tank and the detergent tank and set them on the floor, referring to the section “Emptying the water/detergent tank” and “Emptying the dirty water tank”.
- Pull the handle up perpendicular to the machine.
- Lower the squeegee by operating the lever.
- Tilt the machine backwards and rest the handle on the floor.
- Detach the hose from the diverter valve and from the rear squeegee (fig. 33, ref. 1).
- Wash the hose by directing water into the bore (fig. 32)
- Reattach the hose.

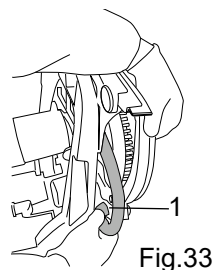
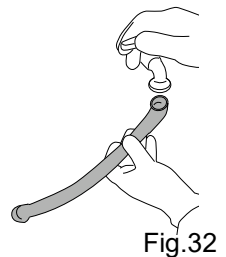
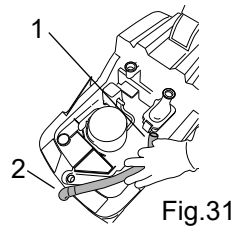
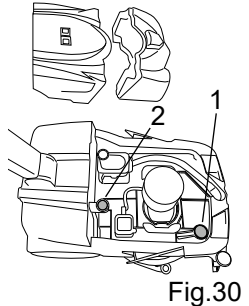
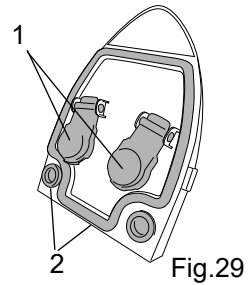

## Cleaning the diverter valve

### ! INFORMATION

This procedure should take place in an area suitable for servicing operations, as the floor will become dirty and wet.

### ! WARNING

Wear overalls, non-slip shoes, gloves and all other items of PPE appropriate for the work environment.

- Remove the dirty water tank and the detergent tank and set them on the floor, referring to the section “Emptying the water/detergent tank” and “Emptying the dirty water tank”.
- Detach the front squeegee suction hose from the diverter valve.
- Detach the rear squeegee suction hose from the diverter valve.
- Release the retaining lever (fig. 35, ref. 1) and remove the cover of the diverter valve.
- Clean the chamber of the valve (fig. 36, ref. 1), removing any encrustations, and rinse with clean water; wipe the seals of the cover with a soft cloth.

### ! INFORMATION

Do not clean seals with ethyl alcohol.

## Cleaning the squeegee

- Remove the dirty water tank and the detergent tank and set them on the floor, referring to the section “Emptying the water/detergent tank” and “Emptying the dirty water tank”.
- Pull the handle up perpendicular to the machine.
- Tilt the machine backwards and rest the handle on the floor.
- Clean the blades of both squeegees with a moist cloth (fig. 37, ref. 1).
- Clean the suction inlet port of both squeegees (fig. 37, ref. 2).

## Squeegee adjustment

The squeegee is factory-adjusted to give an optimum drying action on different types of floor surface, but in the event that results do not meet expectations, there are further adjustments that can be made.

To ensure a faultless drying action, the lip of the squeegee blade should deflect 45° along its entire length, relative to the floor surface; the height of the squeegee can be adjusted by raising or lowering the wheels (fig. 38, ref. 1).

## Replacing the squeegee blades

The squeegee blades collect the film of water and detergent from the floor and prepare the way for perfect drying. With time, the constant wiping action causes the edge of the blade in contact with the floor to become rounded and cracked, with the result that drying is less thorough and the blade must be replaced. Proceed as follows:

- Remove the dirty water tank and the detergent tank and set them on the floor, referring to the section “Emptying the water/detergent tank” and “Emptying the dirty water tank”.

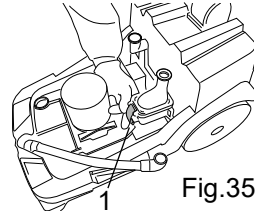

Fig.35

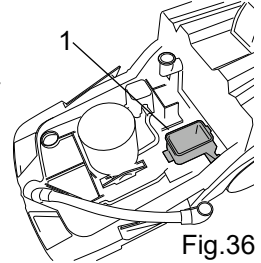

Fig.36



Fig.37

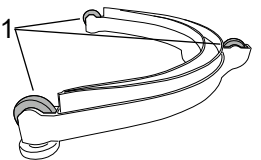
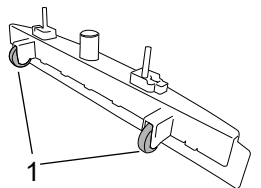

Fig.38





- Pull the handle up perpendicular to the machine.
- Tilt the machine backwards and rest the handle on the floor.

**Front squeegee:**

- Detach the suction hose from the squeegee (fig. 39, ref. 1).
- Unscrew the knobs (fig.39, ref. 2).
- Separate the squeegee from the machine (fig. 40, ref. 1).
- Pull out the blade, so as to free the entire assembly (fig. 41).
- Remove the blade.
- Either refit the same blade with the wiping edges reversed, so that it can be used until both edges are worn out, or replace with a new blade, clipping it to the slots in the body of the squeegee;
- Refit the squeegee to the machine, following the instructions described previously.

**Rear squeegee:**

- Lower the squeegee control lever.
- Detach the suction hose from the squeegee (fig. 42, ref. 1).
- Unscrew the knobs (fig.42, ref. 2).
- Pull out the blade, so as to free the entire assembly (fig. 43, ref. 1).
- Remove the blade (fig. 44).
- Either refit the same blade with the wiping edges reversed, so that it can be used until both edges are worn out, or replace with a new blade, clipping it to the slots in the body of the squeegee;
- Refit the squeegee to the machine, following the instructions described previously.

**Replacing the brush**

The brush presents a number of tufts, coloured red, with bristles shorter in length than the rest (fig. 45). When the tufts of black bristles wear down to the same length as the red bristles, the brush must be replaced. For directions on replacement of the brush, refer to the sections “Releasing the brush/pad driver” and “Fitting the brush/pad driver”.

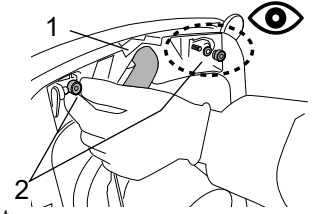

Fig.39

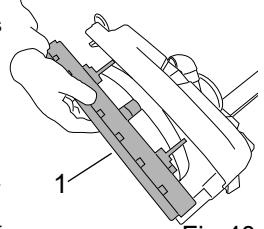

Fig.40

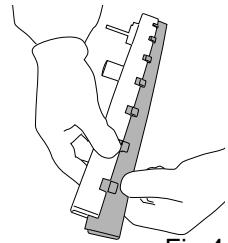

Fig.41

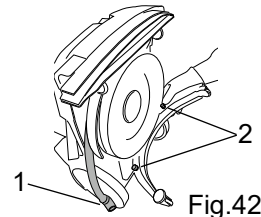

Fig.42

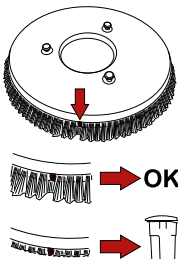

Fig.45

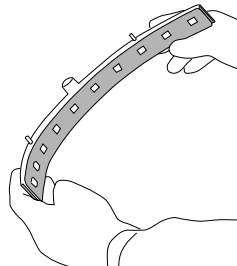

Fig.44

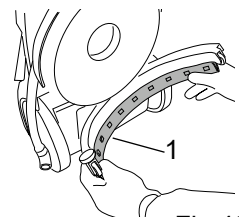

Fig.43

## Periodic checks

CHECK	DAILY OPERATIONS	WEEKLY OPERATIONS	MONTHLY OPERATIONS
Cleaning the dirty water tank	X		
Cleaning the suction floats		X	
Cleaning the water/detergent tank filter		X	
Cleaning the suction filter		X	
Cleaning the front squeegee suction hose	X		
Cleaning the rear squeegee suction hose	X		
Cleaning the diverter valve		X	
Cleaning the squeegee blades	X		
Checking squeegee blade wear		X	
Checking brush wear			X

## TROUBLESHOOTING

[B] Battery powered model.

[C] Mains powered model.

PROBLEM	CAUSE	REMEDY
Machine not working.	[B] Battery low or flat.	[B] Recharge battery
	[C] Plug disconnected.	[C] Connect plug to mains socket
	[B-C] Main switch not activated.	[B-C] Press main switch.
Brush not rotating.	[B-C] Brush control button not depressed.	[B-C] Press brush control button.
	[B-C] Brush control lever not activated.	[B-C] Operate brush control lever.
Brush motor not starting easily.	[B-C] Machine is working with a dry brush on a particularly rough floor.	Increase the quantity of detergent.
Machine not scrubbing uniformly.	[B-C] Brush or pad worn.	[B-C] Replace brush.
Detergent solution not reaching brush.	[B-C] Detergent tank empty	[B-C] Fill detergent tank.
	[B-C] Water/detergent tank filter dirty.	[B-C] Clean filter.
	[B-C] Blockage in hose delivering detergent solution to brush.	[B-C] Remove blockage.
Suction motor not working.	[B-C] Suction control button not depressed.	[B-C] Press suction control button.

Squeegee not cleaning or vacuum weak.	[B-C] Lip of rubber blades in contact with the floor has become worn.	[B-C] Replace squeegee blade.
	[B-C] Float controlled shut-off has been tripped (dirty water tank full).	[B-C] Empty out dirty water tank.
	[B-C] Blockage in squeegee suction hose.	[B-C] Remove blockage.
	[B-C] Suction hose either not connected to squeegee, or damaged.	[B-C] Connect or repair suction hose.
	[B-C] Diverter valve dirty.	[B-C] Clean diverter valve.
Battery not giving expected operational endurance.	[B] Battery charger not working.	[B] Replace battery charger.

## **ALARMS**

Brush motor thermal overload.	Red Led alight on brush control button, 1 slow blink	Switch off all functions of the machine. Remove the dirty water tank to let more air into the motor housing. Wait a few minutes, then restart the machine. If the problem persists, contact customer service.
Brush motor overcurrent/short circuit.	Red Led alight on brush control button, 1 fast blink.	Switch off all functions of the machine. Restart the machine. If the alarm appears again, make certain that the brush is not being used on a particularly rough floor. If the problem persists, contact customer service.
Detergent pump overcurrent/short circuit.	Red Led alight on brush control button, 2 fast blinks.	Switch off all functions of the machine. Restart the machine. If the problem persists, contact customer service.
Suction motor overcurrent/short circuit.	Red Led alight on suction control button, 1 fast blink.	Switch off all functions of the machine. Restart the machine. If the problem persists, contact customer service.
Excess battery voltage.	Green battery charge Led blinking.	Check the integrity, operation and use of the battery charger supplied with the machine.



**IPC**

IP Cleaning S.r.l  
Viale Treviso 63  
30026 Summaga di Portogruaro  
Venezia (Italy)  
T: +39 0421 205511  
F: +39 0421 204227  
E: [www.ipcworldwide.com](http://www.ipcworldwide.com)  
W: [info@ipcworldwide.com](mailto:info@ipcworldwide.com)

